

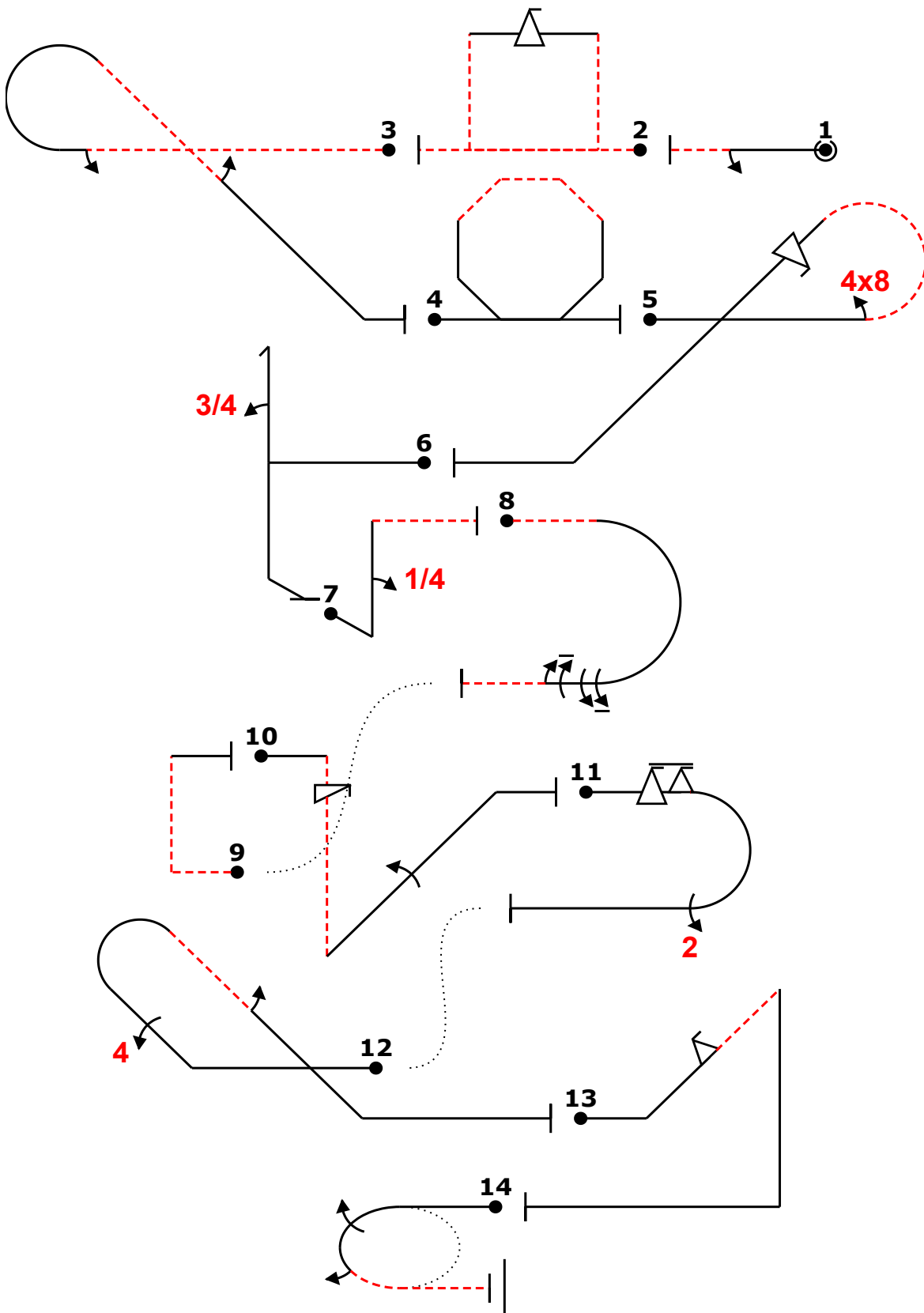

ЧР, Усмань-Шаршки 2021		Form B
Pilot ID	CIVA Advanced Unknown1	Flight #

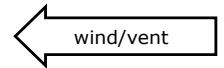

Power			
Fig	Aresti	K	
1	1.1.1.3	2	6
Add.	9.1.3.2	4	
2	7.4.3.2	19	30
	9.9.3.4	11	
3	8.5.8.2	11	6
Add.	9.1.3.2	4	
	9.1.4.2	4	
4	7.4.6.1	19	19
5	8.5.7.1	12	30
	9.8.3.2	7	
	9.9.4.4	11	
6	5.2.1.1	17	27
	9.1.1.3	10	
7	1.1.7.1	9	6
Add.	9.1.1.1	6	
8	7.2.2.4	7	29
	9.1.3.8	12	
	9.1.3.6	10	
9	1.1.7.2	12	6
Add.			
10	1.2.6.3	15	30
	9.11.1.4	5	
	9.1.2.4	10	
11	7.2.3.3	6	29
	9.9.3.6	14	
	9.2.3.4	9	
12	8.4.14.1	12	29
	9.4.2.4	13	
	9.1.4.2	4	
13	1.2.3.1	12	25
	9.9.2.2	13	
14	2.2.3.3	26	26
Total K = 298			

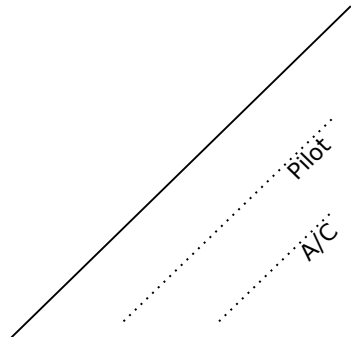

Вариант В



ЧР, Усмань-Шаршки 2021		Form B
Pilot ID	CIVA Advanced Unknown1	
		Flight #

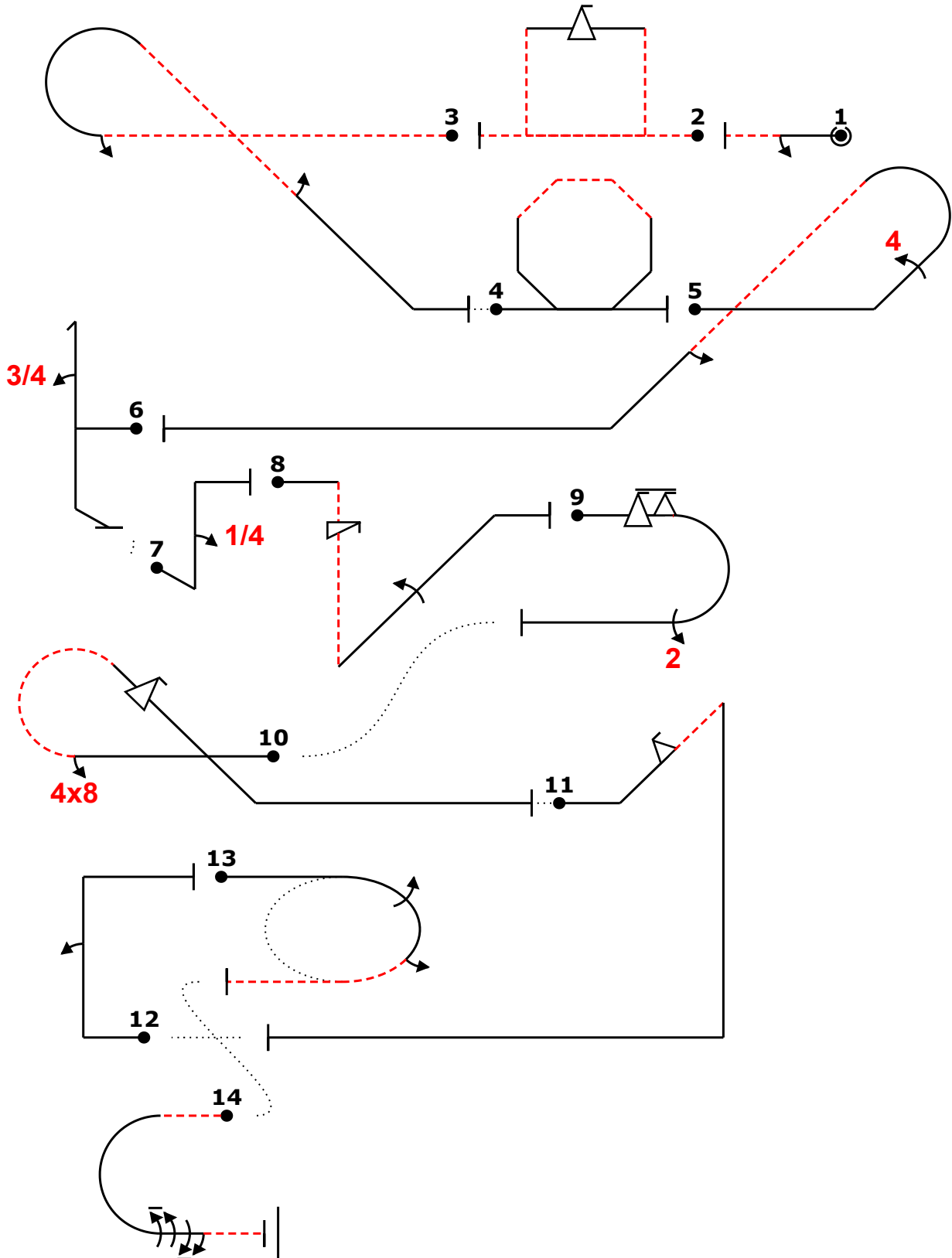
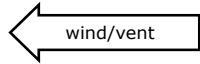

Power			
Fig	Aresti	K	
1	1.1.1.3	2	6
Add.	9.1.3.2	4	
2	7.4.3.2	19	30
E	9.9.3.4	11	
3	8.5.8.2	11	6
Add.	9.1.3.2	4	
	9.1.4.2	4	
4	7.4.6.1	19	19
5	8.4.14.1	12	29
J	9.4.2.4	13	
	9.1.4.2	4	
6	5.2.1.1	17	27
G	9.1.1.3	10	
7	1.1.6.1	10	6
Add.	9.1.1.1	6	
8	1.2.6.3	15	30
B	9.11.1.4	5	
	9.1.2.4	10	
9	7.2.3.3	6	29
D	9.9.3.6	14	
	9.2.3.4	9	
10	8.5.7.1	12	30
C	9.8.3.2	7	
	9.9.4.4	11	
11	1.2.3.1	12	25
A	9.9.2.2	13	
12	1.1.6.1	10	6
Add.	9.1.1.2	8	
13	2.2.3.3	26	26
14	7.2.2.4	7	29
H	9.1.3.8	12	
	9.1.3.6	10	
Total K = 298			

_____/ Pilot
/ A/C

Вариант С



ЧР, Усмань-Шаршки 2021		Form B
Pilot ID	CIVA Advanced Unknown1	Flight #

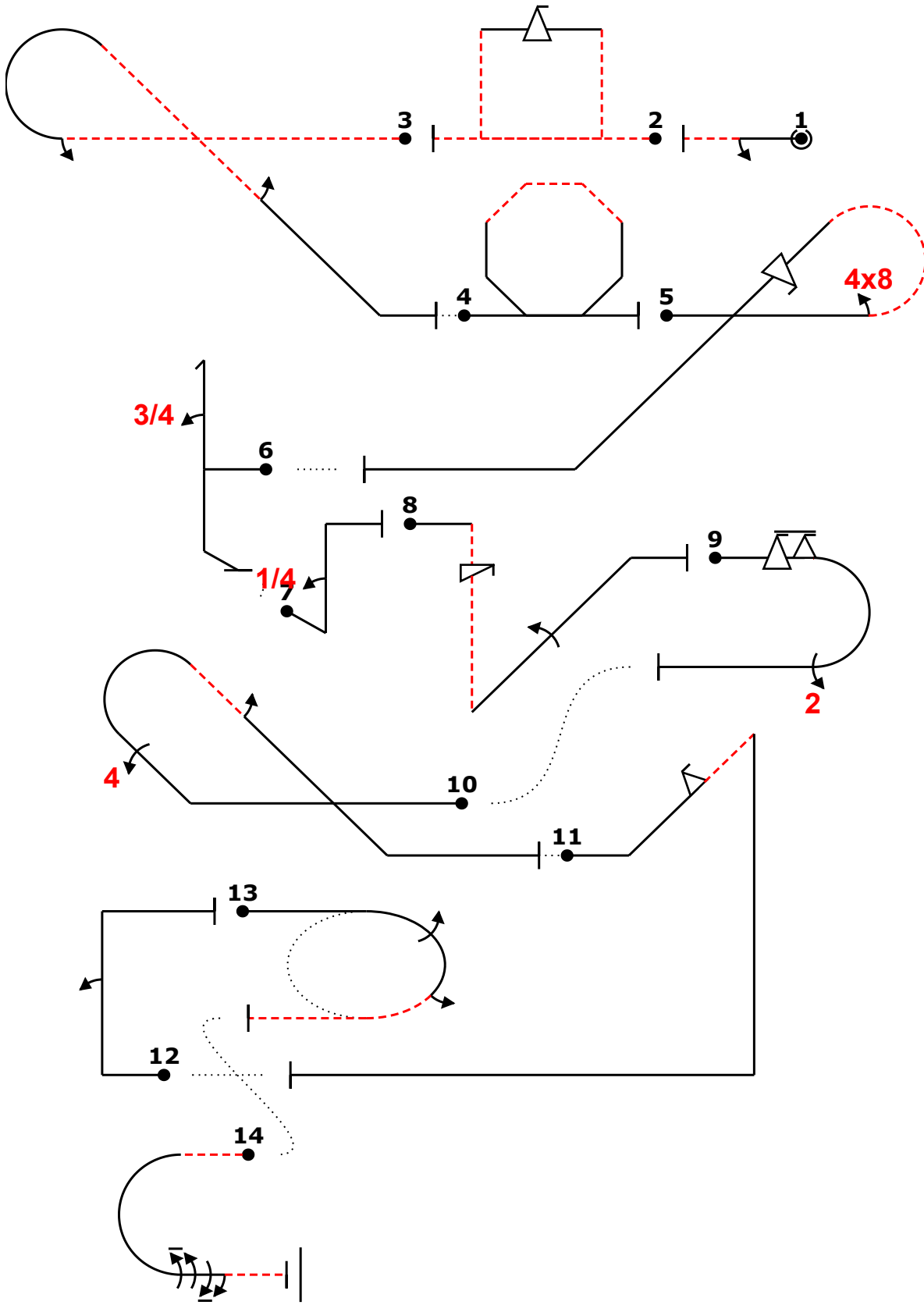
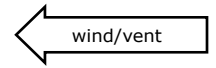

Power			
Fig	Aresti	K	
1	1.1.1.3	2	6
Add.	9.1.3.2	4	
2	7.4.3.2	19	30
	9.9.3.4	11	
3	8.5.8.2	11	6
Add.	9.1.3.2	4	
	9.1.4.2	4	
4	7.4.6.1	19	19
5	8.5.7.1	12	30
	9.8.3.2	7	
	9.9.4.4	11	
6	5.2.1.1	17	27
	9.1.1.3	10	
7	1.1.6.1	10	6
Add.	9.1.1.1	6	
8	1.2.6.3	15	30
	9.11.1.4	5	
	9.1.2.4	10	
9	7.2.3.3	6	29
	9.9.3.6	14	
	9.2.3.4	9	
10	8.4.14.1	12	29
	9.4.2.4	13	
	9.1.4.2	4	
11	1.2.3.1	12	25
	9.9.2.2	13	
12	1.1.6.1	10	6
Add.	9.1.1.2	8	
13	2.2.3.3	26	26
14	7.2.2.4	7	29
	9.1.3.8	12	
	9.1.3.6	10	
Total K = 298			

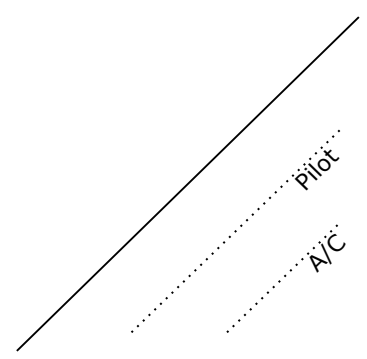

Вариант D



ЧР, Усмань-Шаршки (ММ-ver)		Form B
Pilot ID	CIVA Advanced Unknown1	Flight #

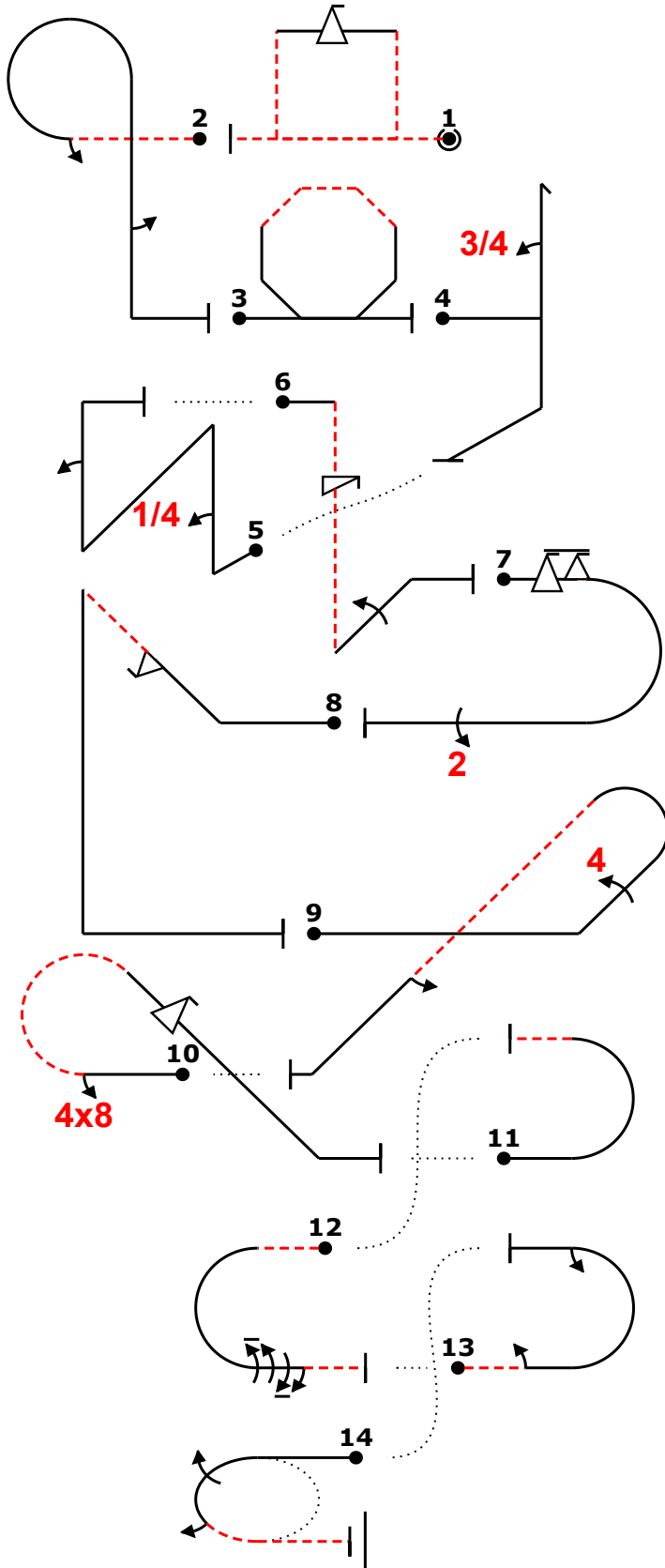
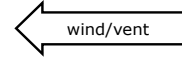

Power			
Fig	Aresti	K	
1	7.4.3.2 E 9.9.3.4	19 11	30
2	8.6.7.2 Add. 9.1.3.2 9.1.5.2	12 4 4	6
3	7.4.6.1 F	19	19
4	5.2.1.1 G 9.1.1.3	17 10	27
5	1.3.13.1 Add. 9.1.1.1 9.1.1.2	22 6 8	6
6	1.2.6.3 B 9.11.1.4 9.1.2.4	15 5 10	30
7	7.2.3.3 D 9.9.3.6 9.2.3.4	6 14 9	29
8	1.2.3.1 A 9.9.2.2	12 13	25
9	8.4.14.1 J 9.4.2.4 9.1.4.2	12 13 4	29
10	8.5.7.1 C 9.8.3.2 9.9.4.4	12 7 11	30
11	7.2.1.1 Add.	6	6
12	7.2.2.4 H 9.1.3.8 9.1.3.6	7 12 10	29
13	7.2.4.2 Add. 9.1.3.2 9.1.3.2	6 4 4	6
14	2.2.3.3 I	26	26
Total K = 298			

_____ Pilot
 A/C



ЧР, Усмань-Шаршки 2021		Form B
Pilot ID	CIVA Advanced Unknown1	Flight #

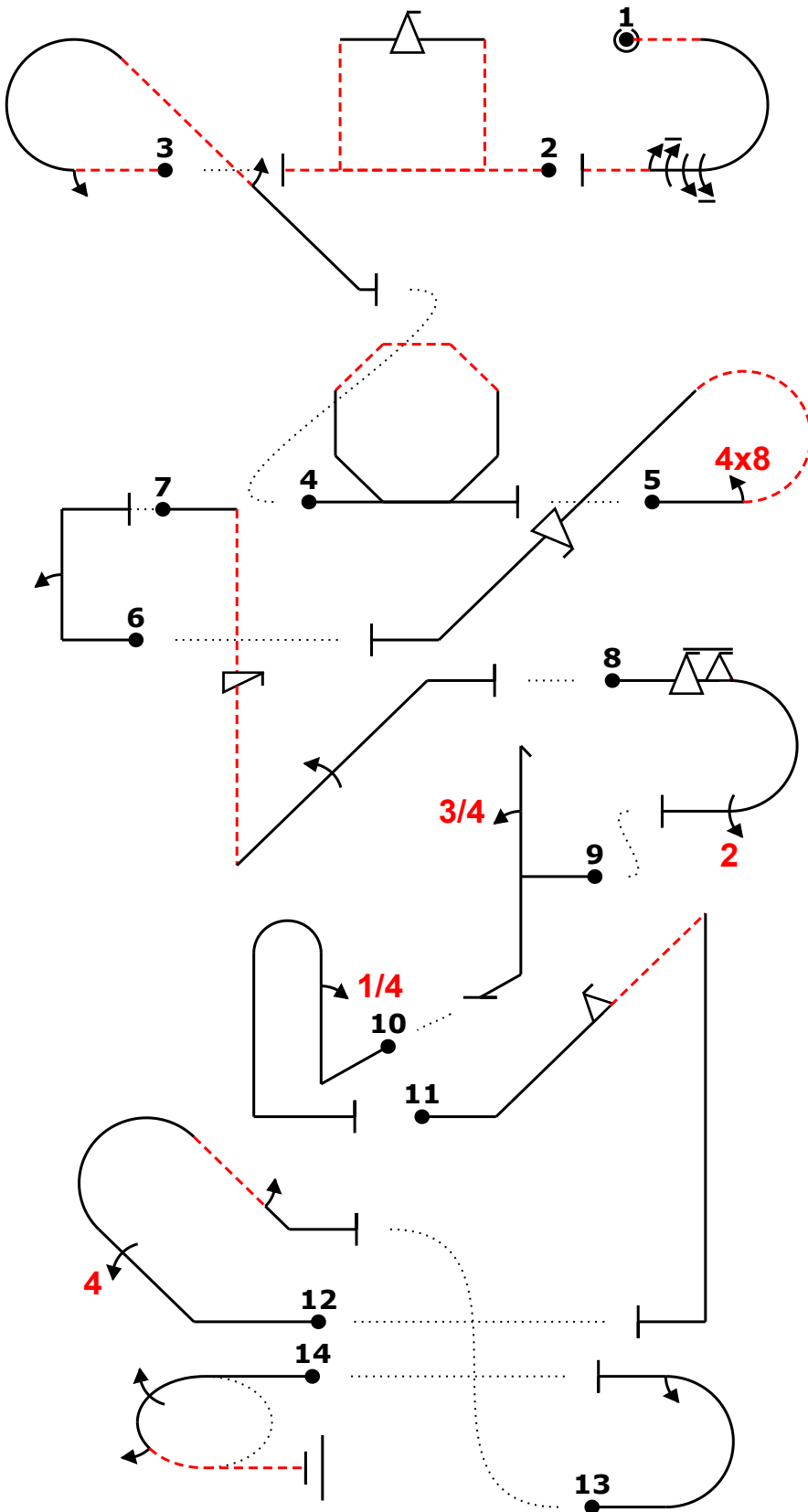
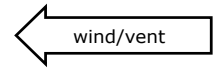

Power			
Fig	Aresti	K	
1 H	7.2.2.4	7	29
	9.1.3.8	12	
	9.1.3.6	10	
2 E	7.4.3.2	19	30
	9.9.3.4	11	
3 Add.	8.5.8.2	11	6
	9.1.3.2	4	
	9.1.4.2	4	
4 F	7.4.6.1	19	19
5 C	8.5.7.1	12	30
	9.8.3.2	7	
	9.9.4.4	11	
6 Add.	1.1.6.1	10	6
	9.1.1.2	8	
7 B	1.2.6.3	15	30
	9.11.1.4	5	
	9.1.2.4	10	
8 D	7.2.3.3	6	29
	9.9.3.6	14	
	9.2.3.4	9	
9 G	5.2.1.1	17	27
	9.1.1.3	10	
10 Add.	8.4.1.1	13	6
	9.1.1.1	6	
11 A	1.2.3.1	12	25
	9.9.2.2	13	
12 J	8.4.14.1	12	29
	9.4.2.4	13	
	9.1.4.2	4	
13 Add.	7.2.2.1	6	6
	9.1.3.2	4	
14 I	2.2.3.3	26	26
Total K = 298			

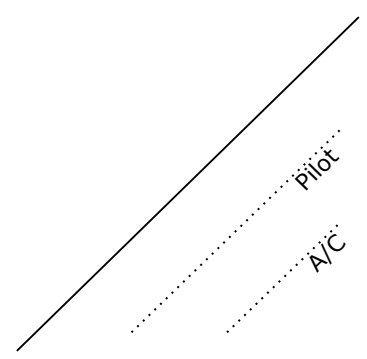



ЧР, Усмань-Шаршки 2021		Form B
Pilot ID	CIVA Advanced Unknown1	Flight #

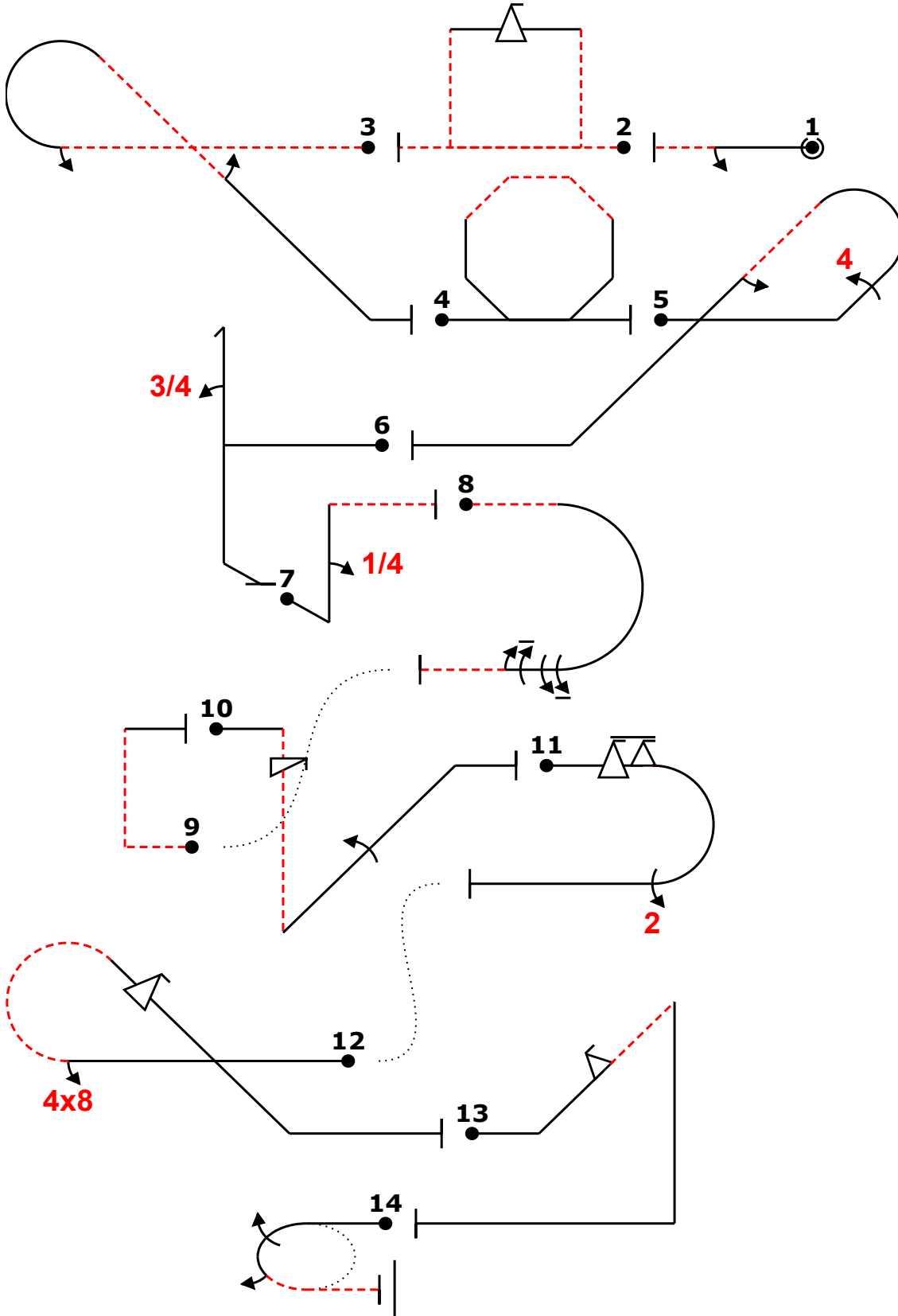
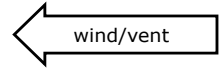

Power			
Fig	Aresti	K	
1	1.1.1.3	2	6
Add.	9.1.3.2	4	
2	7.4.3.2	19	30
E	9.9.3.4	11	
3	8.5.8.2	11	6
Add.	9.1.3.2	4	
	9.1.4.2	4	
4	7.4.6.1	19	19
5	8.4.14.1	12	29
J	9.4.2.4	13	
	9.1.4.2	4	
6	5.2.1.1	17	27
G	9.1.1.3	10	
7	1.1.7.1	9	6
Add.	9.1.1.1	6	
8	7.2.2.4	7	29
H	9.1.3.8	12	
	9.1.3.6	10	
9	1.1.7.2	12	6
Add.			
10	1.2.6.3	15	30
B	9.11.1.4	5	
	9.1.2.4	10	
11	7.2.3.3	6	29
D	9.9.3.6	14	
	9.2.3.4	9	
12	8.5.7.1	12	30
C	9.8.3.2	7	
	9.9.4.4	11	
13	1.2.3.1	12	25
A	9.9.2.2	13	
14	2.2.3.3	26	26
I			
Total K = 298			

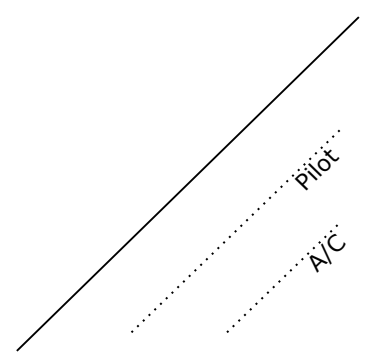



ЧР, Усмань-Шаршки 2021		Form B
Pilot ID	CIVA Advanced Unknown1	Flight #

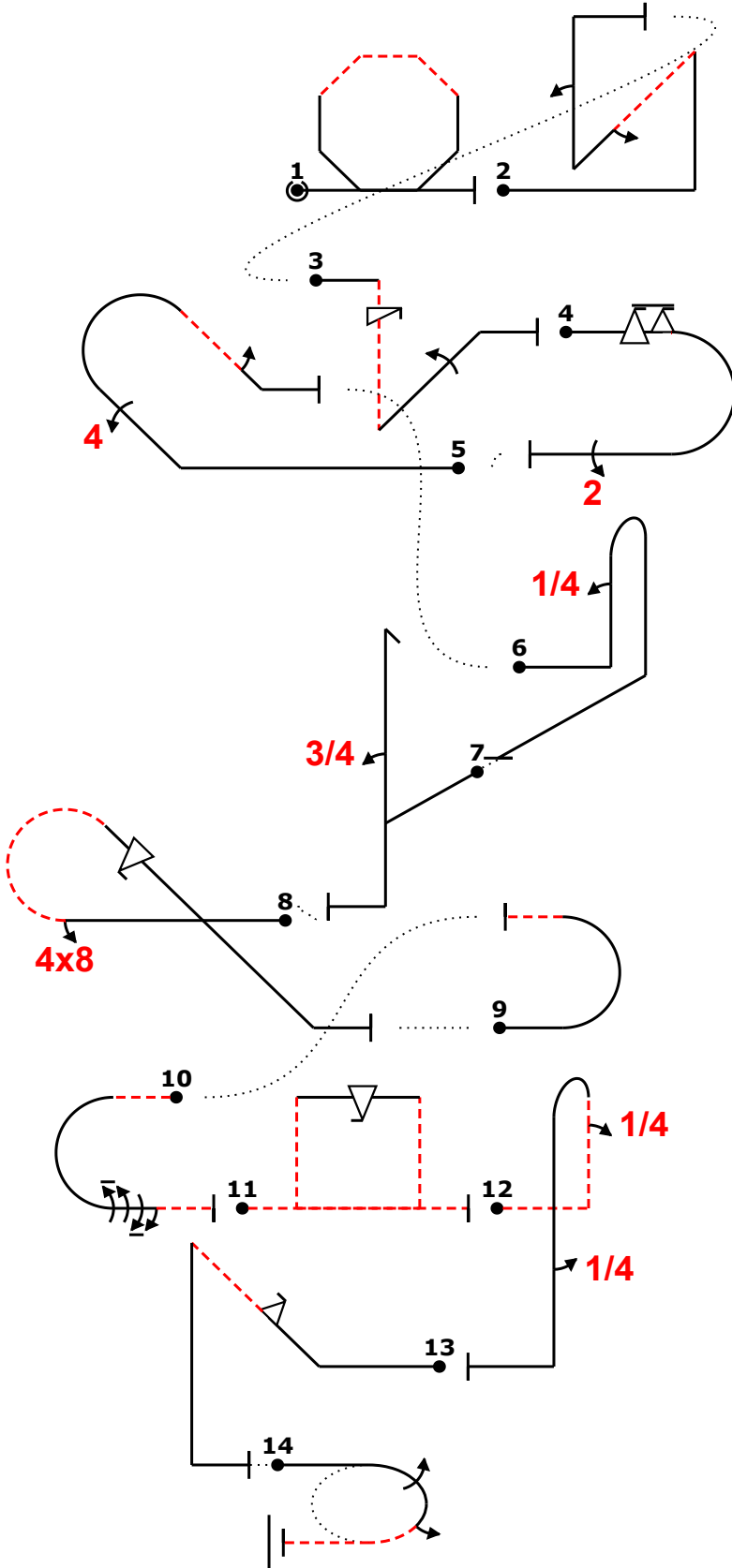
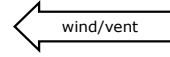

Power			
Fig	Aresti	K	
1 F	7.4.6.1	19	19
2 Add.	1.3.12.1	21	6
	9.1.4.2	4	
	9.1.1.2	8	
3 B	1.2.6.3	15	30
	9.11.1.4	5	
	9.1.2.4	10	
4 D	7.2.3.3	6	29
	9.9.3.6	14	
	9.2.3.4	9	
5 J	8.4.14.1	12	29
	9.4.2.4	13	
	9.1.4.2	4	
6 Add.	8.4.1.1	13	6
	9.1.1.1	6	
7 G	5.2.1.1	17	27
	9.1.1.3	10	
8 C	8.5.7.1	12	30
	9.8.3.2	7	
	9.9.4.4	11	
9 Add.	7.2.1.1	6	6
10 H	7.2.2.4	7	29
	9.1.3.8	12	
	9.1.3.6	10	
11 E	7.4.3.2	19	30
	9.9.3.4	11	
12 Add.	8.4.4.2	14	6
	9.1.1.1	6	
	9.1.5.1	2	
13 A	1.2.3.1	12	25
	9.9.2.2	13	
14 I	2.2.3.3	26	26
Total K = 298			

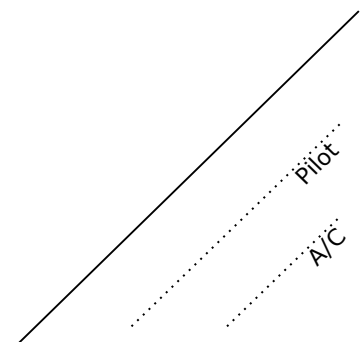



ЧР, Усмань-Шаршки 2021		Form B
Pilot ID	CIVA Advanced Unknown1	Flight #

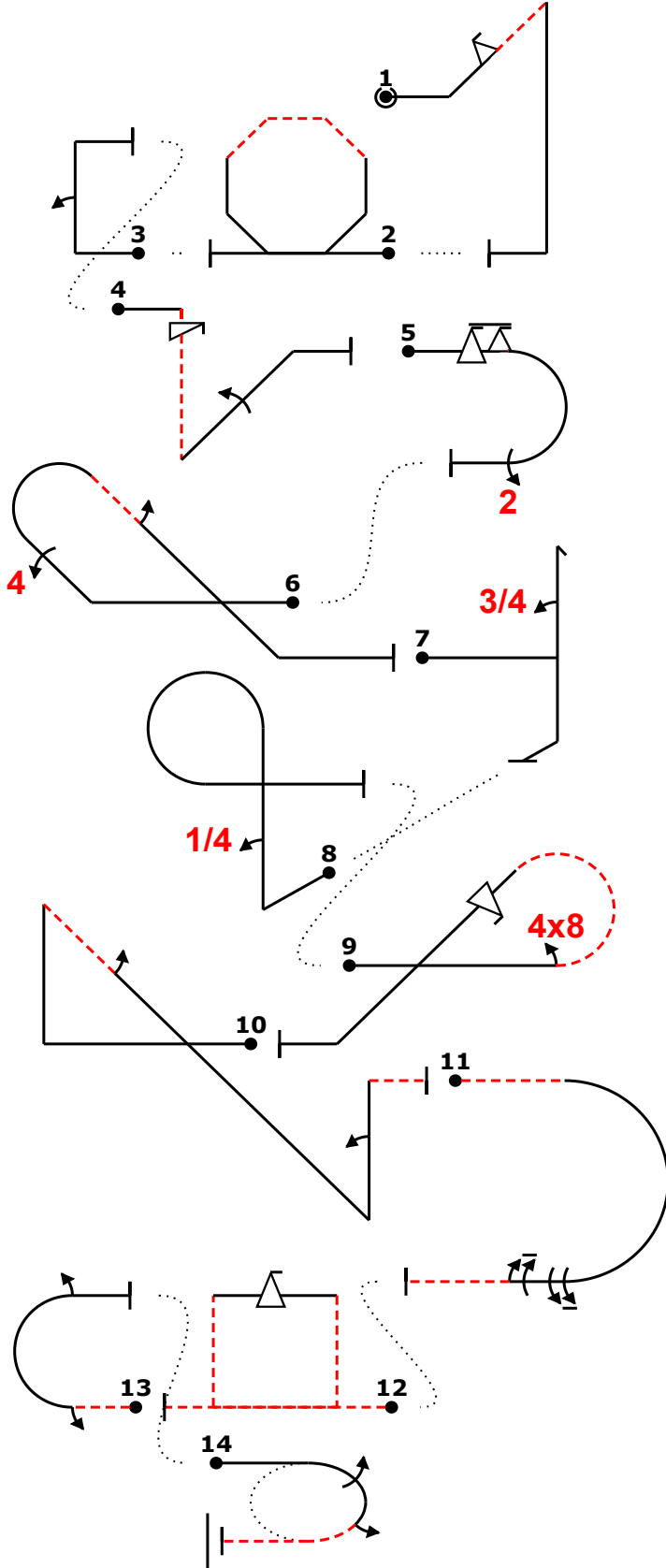
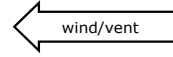

Power			
Fig	Aresti	K	
1	1.2.3.1 9.9.2.2	12 13	25
2	7.4.6.1	19	19
3	1.1.6.1 9.1.1.2	10 8	6
4	1.2.6.3 9.1.1.4 9.1.2.4	15 5 10	30
5	7.2.3.3 9.9.3.6 9.2.3.4	6 14 9	29
6	8.4.14.1 9.4.2.4 9.1.4.2	12 13 4	29
7	5.2.1.1 9.1.1.3	17 10	27
8	8.6.1.1 9.1.1.1	11 6	6
9	8.5.7.1 9.8.3.2 9.9.4.4	12 7 11	30
10	1.3.11.1 9.1.4.2 9.1.1.2	20 4 8	6
11	7.2.2.4 9.1.3.8 9.1.3.6	7 12 10	29
12	7.4.3.2 9.9.3.4	19 11	30
13	7.2.4.2 9.1.3.2 9.1.3.2	6 4 4	6
14	2.2.3.3	26	26
Total K = 298			

Pilot
A/C