

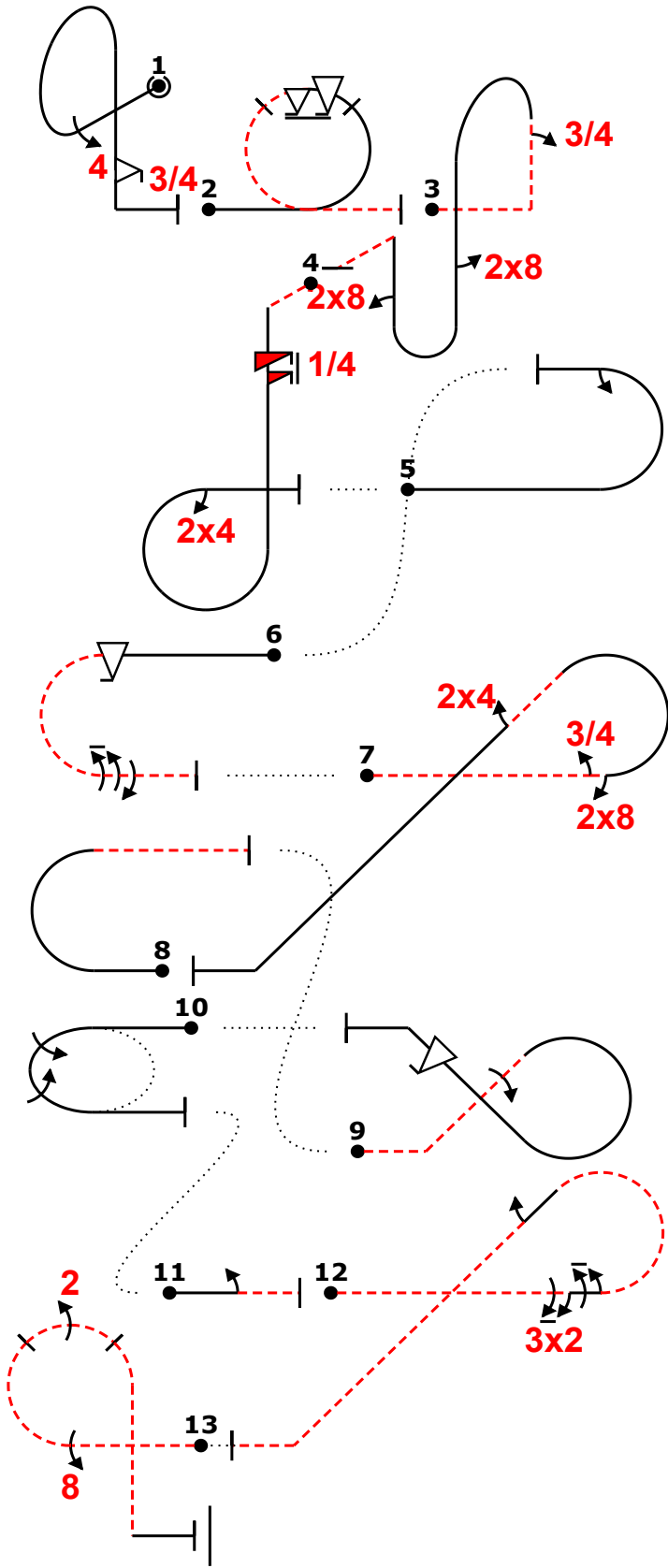

		Form B
Pilot ID	CIVA Advanced Unknown3	Flight #

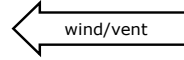

Power			
Fig	Aresti	K	
1 B	8.6.5.1	11	33
	9.4.3.4	11	
	9.9.5.3	11	
2	7.4.2.1	12	26
	9.9.3.6	14	
3 D	8.8.8.2	20	40
	9.1.1.3	10	
	9.8.5.1	3	
	9.8.1.1	7	
4 C	8.6.2.4	12	23
	9.12.1.5	6	
	9.4.3.2	5	
5 Add.	7.2.2.1	6	8
	9.1.3.2	4	
6 A	7.2.1.3	8	39
	9.9.3.4	11	
	9.1.3.8	12	
	9.1.3.4	8	
7 I	8.5.8.2	11	25
	9.1.3.3	6	
	9.8.3.1	3	
	9.4.4.2	5	
8 Add.	7.2.1.1	6	8
9 G	7.3.1.2	14	37
	9.1.2.4	10	
	9.9.2.4	13	
10 J	2.2.5.1	22	22
11 Add.	1.1.1.3	2	8
	9.1.3.2	4	
12 H	8.5.6.2	14	40
	9.2.3.6	12	
	9.1.3.6	10	
	9.1.4.2	4	
13 E	8.6.6.2	15	39
	9.8.3.4	15	
	9.2.3.4	9	
Total K = 348			

_____ Pilot
 A/C



ЧР, Усмант-Шаршки 2021		Form B
Pilot ID	CIVA Advanced Unknown3	Flight #

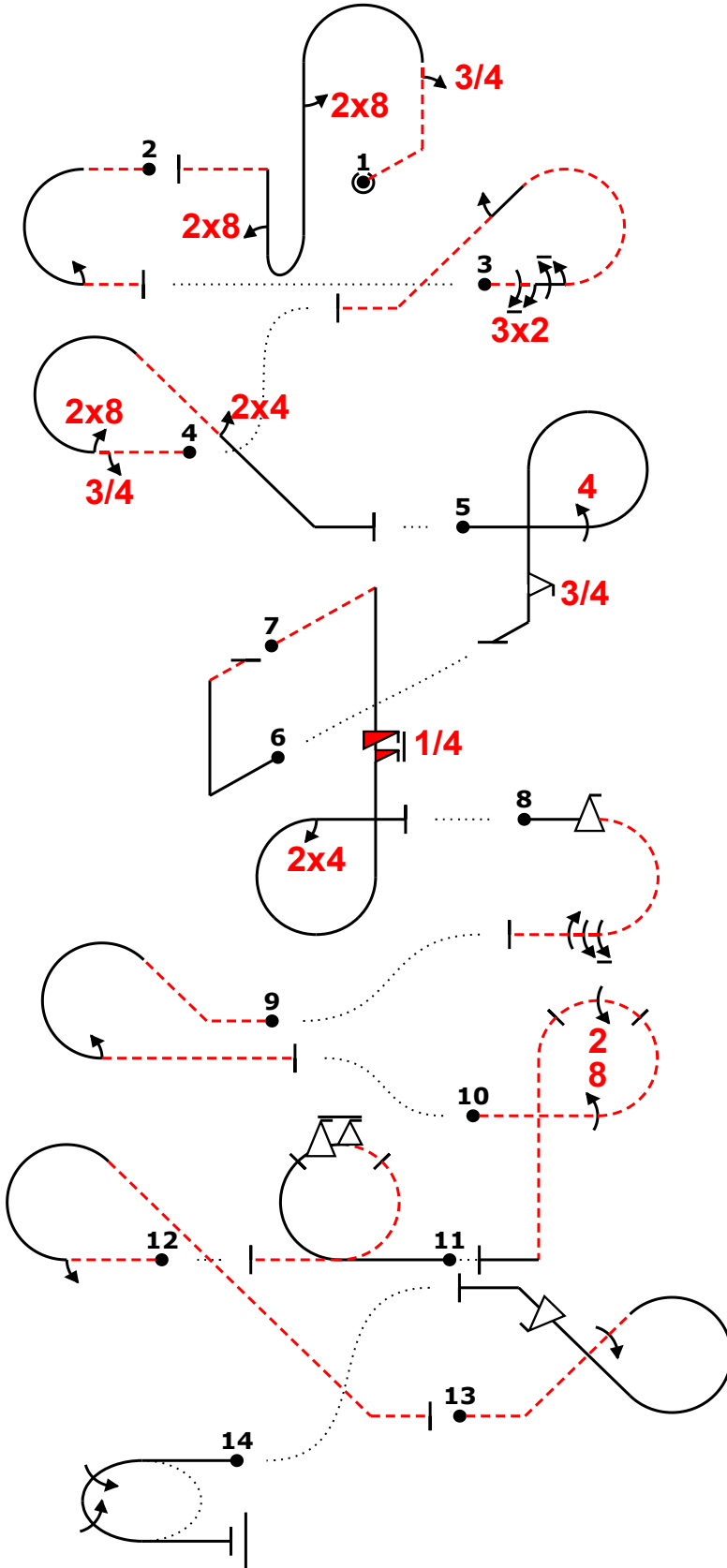
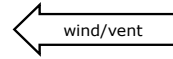

Power			
Fig	Aresti	K	
1 D	8.8.8.2	20	40
	9.1.1.3	10	
	9.8.5.1	3	
	9.8.1.1	7	
2 Add.	7.2.2.4	7	8
	9.1.3.2	4	
3 H	8.5.6.2	14	40
	9.2.3.6	12	
	9.1.3.6	10	
	9.1.4.2	4	
4 I	8.5.8.2	11	25
	9.1.3.3	6	
	9.8.3.1	3	
	9.4.4.2	5	
5 B	8.6.5.1	11	33
	9.4.3.4	11	
	9.9.5.3	11	
6 Add.	1.1.7.1	9	8
7 C	8.6.2.4	12	23
	9.12.1.5	6	
	9.4.3.2	5	
8 A	7.2.1.3	8	39
	9.9.3.4	11	
	9.1.3.8	12	
	9.1.3.4	8	
9	8.5.3.2	11	15
	9.1.3.2	4	
10 E	8.6.6.2	15	39
	9.8.3.4	15	
	9.2.3.4	9	
11 F	7.4.2.1	12	26
	9.9.3.6	14	
12 Add.	8.5.7.2	11	8
	9.1.3.2	4	
13 G	7.3.1.2	14	37
	9.1.2.4	10	
	9.9.2.4	13	
14 J	2.2.5.1	22	22
Total K = 363			

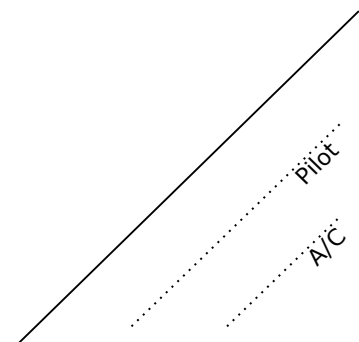

Вариант С



ЧР, Усмань-Шаршки 2021		Form B
Pilot ID	CIVA Advanced Unknown3	Flight #

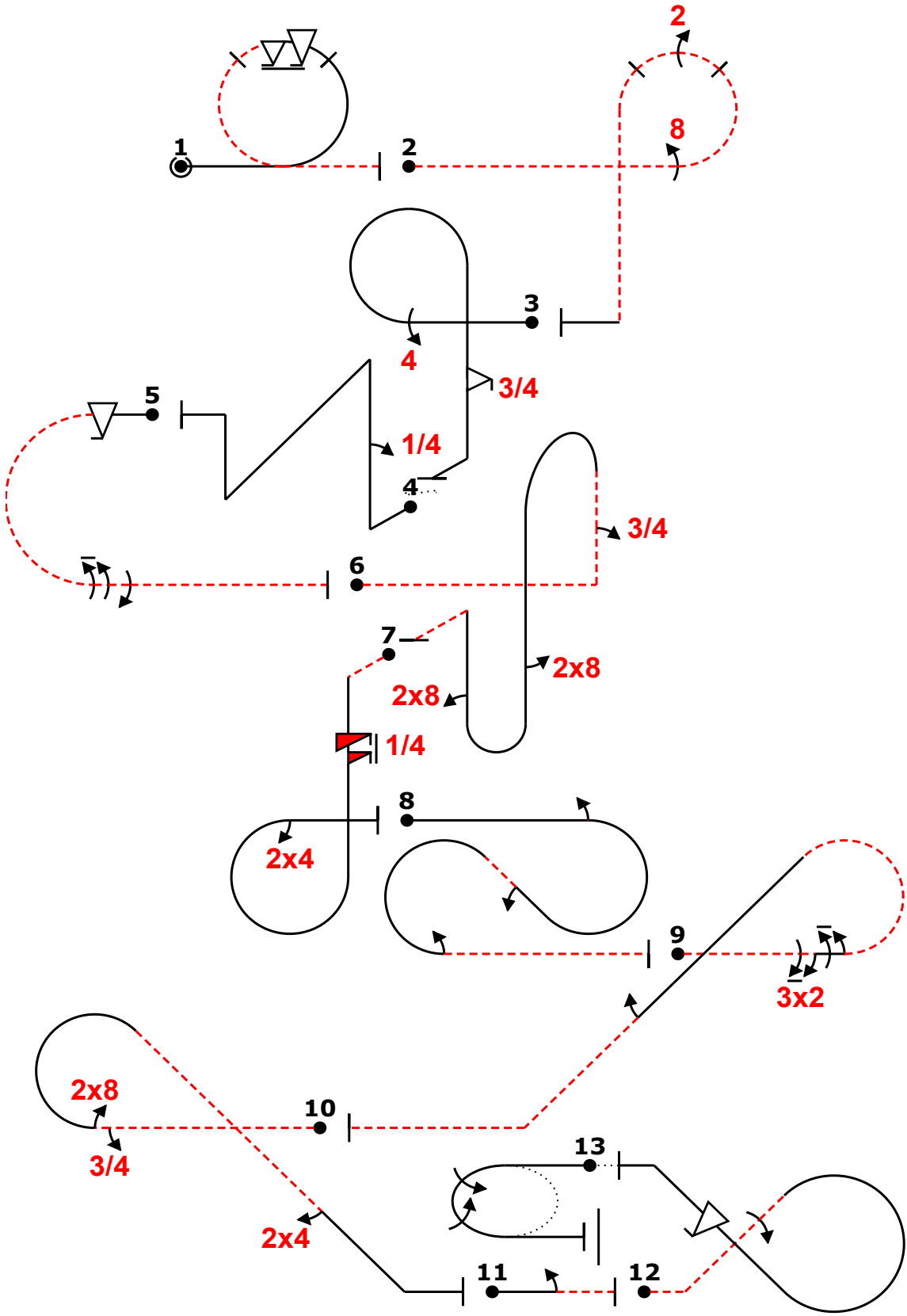
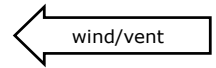

Power			
Fig	Aresti	K	
1 F	7.4.2.1	12	26
	9.9.3.6	14	
2 E	8.6.6.2	15	39
	9.8.3.4	15	
	9.2.3.4	9	
3 B	8.6.5.1	11	33
	9.4.3.4	11	
	9.9.5.3	11	
4 Add.	1.3.13.1	22	8
	9.1.1.1	6	
5 A	7.2.1.3	8	39
	9.9.3.4	11	
	9.1.3.8	12	
	9.1.3.4	8	
6 D	8.8.8.2	20	40
	9.1.1.3	10	
	9.8.5.1	3	
	9.8.1.1	7	
7 C	8.6.2.4	12	23
	9.12.1.5	6	
	9.4.3.2	5	
8 Add.	7.5.8.3	15	8
	9.1.3.2	4	
	9.1.2.2	6	
	9.1.3.2	4	
9 H	8.5.6.2	14	40
	9.2.3.6	12	
	9.1.3.6	10	
	9.1.4.2	4	
10 I	8.5.8.2	11	25
	9.1.3.3	6	
	9.8.3.1	3	
	9.4.4.2	5	
11 Add.	1.1.1.3	2	8
	9.1.3.2	4	
12 G	7.3.1.2	14	37
	9.1.2.4	10	
	9.9.2.4	13	
13 J	2.2.5.1	22	22
Total K = 348			

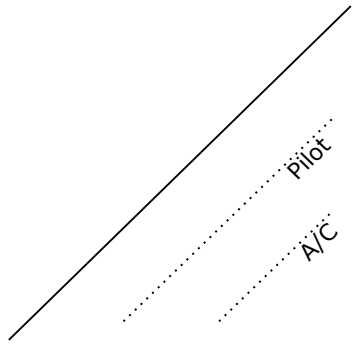

Вариант D



ЧР, Усмань-Шарцки 2021		Form B
Pilot ID	CIVA Advanced Unknown3	Flight #

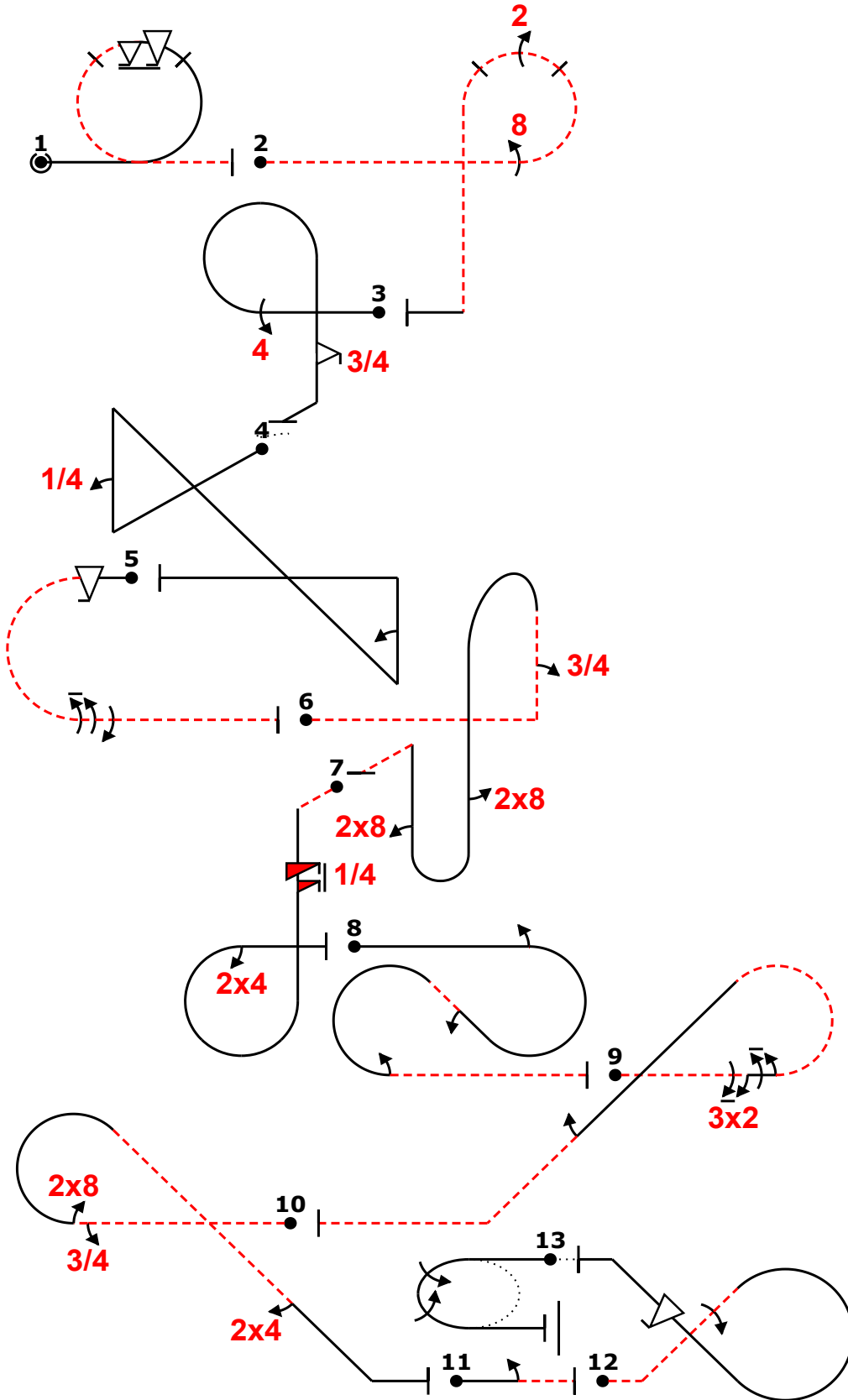
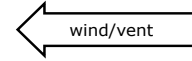

Power			
Fig	Aresti	K	
1	7.4.2.1	12	26
	F 9.9.3.6	14	
2	8.6.6.2	15	39
	E 9.8.3.4	15	
	9.2.3.4	9	
3	B 8.6.5.1	11	33
	9.4.3.4	11	
	9.9.5.3	11	
4	Add. 1.3.13.1	22	8
	9.1.1.1	6	
	9.1.1.2	8	
5	A 7.2.1.3	8	39
	9.9.3.4	11	
	9.1.3.8	12	
	9.1.3.4	8	
6	D 8.8.8.2	20	40
	9.1.1.3	10	
	9.8.5.1	3	
	9.8.1.1	7	
7	C 8.6.2.4	12	23
	9.12.1.5	6	
	9.4.3.2	5	
8	Add. 7.5.8.3	15	8
	9.1.3.2	4	
	9.1.2.2	6	
	9.1.3.2	4	
9	H 8.5.6.2	14	40
	9.2.3.6	12	
	9.1.3.6	10	
	9.1.4.2	4	
10	I 8.5.8.2	11	25
	9.1.3.3	6	
	9.8.3.1	3	
	9.4.4.2	5	
11	Add. 1.1.1.3	2	8
	9.1.3.2	4	
12	G 7.3.1.2	14	37
	9.1.2.4	10	
	9.9.2.4	13	
13	J 2.2.5.1	22	22
Total K = 348			

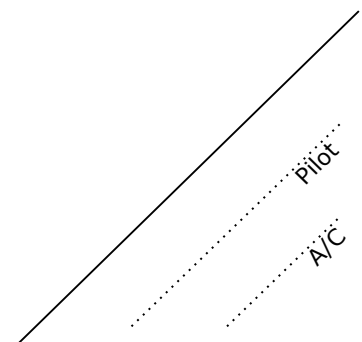



ЧР, Усмань-Шаршки 2021		Form B
Pilot ID	CIVA Advanced Unknown3	Flight #

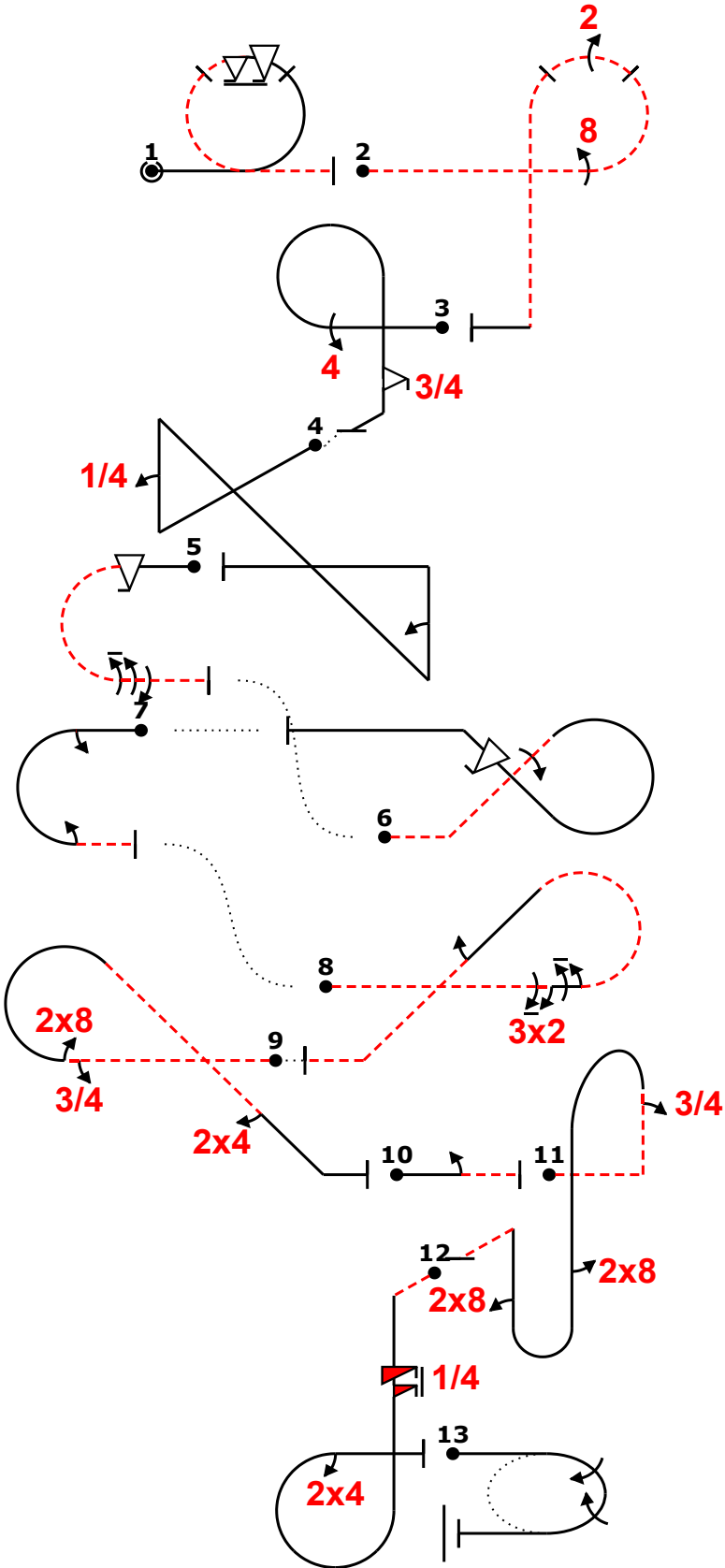
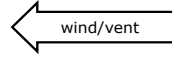

Power			
Fig	Aresti	K	
1	7.4.2.1	12	26
	9.9.3.6	14	
2	8.6.6.2	15	39
	9.8.3.4	15	
	9.2.3.4	9	
3	8.6.5.1	11	33
	9.4.3.4	11	
	9.9.5.3	11	
4	1.3.13.1	22	8
	9.1.1.1	6	
	9.1.1.2	8	
5	7.2.1.3	8	39
	9.9.3.4	11	
	9.1.3.8	12	
	9.1.3.4	8	
6	7.3.1.2	14	37
	9.1.2.4	10	
	9.9.2.4	13	
7	7.2.4.3	6	8
	9.1.3.2	4	
	9.1.3.2	4	
8	8.5.6.2	14	40
	9.2.3.6	12	
	9.1.3.6	10	
	9.1.4.2	4	
9	8.5.8.2	11	25
	9.1.3.3	6	
	9.8.3.1	3	
	9.4.4.2	5	
10	1.1.1.3	2	8
	9.1.3.2	4	
	9.1.3.2	2	
11	8.8.8.2	20	40
	9.1.1.3	10	
	9.8.5.1	3	
	9.8.1.1	7	
12	8.6.2.4	12	23
	9.12.1.5	6	
	9.4.3.2	5	
13	2.2.5.1	22	22
Total K = 348			

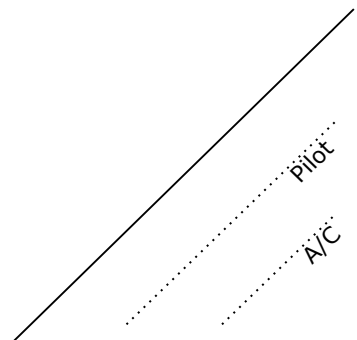



		Form B
Pilot ID	CIVA Advanced Unknown3	Flight #

← wind/vent

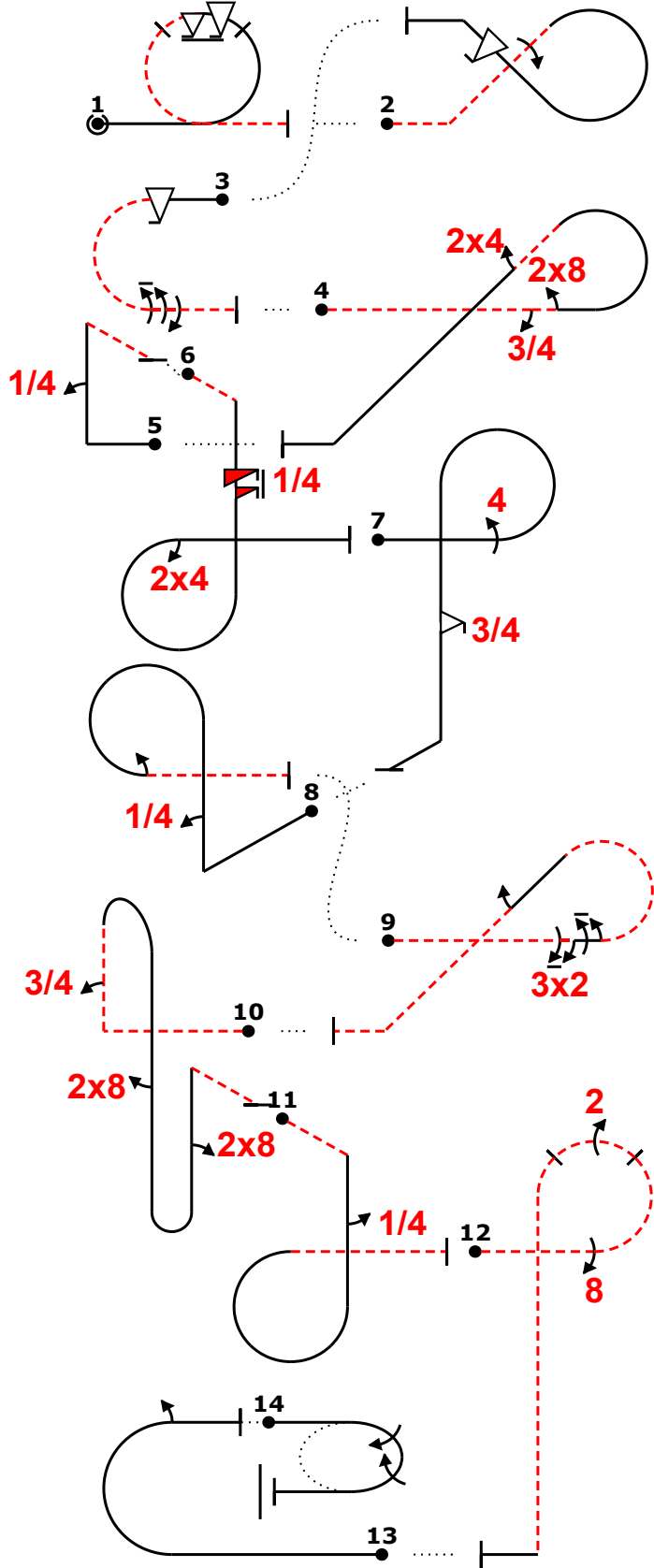

Power			
Fig	Aresti	K	
1	7.4.2.1	12	26
	9.9.3.6	14	
2	7.3.1.2	14	37
	9.1.2.4	10	
	9.9.2.4	13	
3	7.2.1.3	8	39
	9.9.3.4	11	
	9.1.3.8	12	
	9.1.3.4	8	
4	8.5.8.2	11	25
	9.1.3.3	6	
	9.8.3.1	3	
	9.4.4.2	5	
5	1.1.7.1	9	6
	9.1.1.1	6	
6	8.6.2.4	12	23
	9.12.1.5	6	
	9.4.3.2	5	
7	8.6.5.1	11	33
	9.4.3.4	11	
	9.9.5.3	11	
8	8.6.2.1	12	6
	9.1.1.1	6	
	9.1.3.2	4	
9	8.5.6.2	14	40
	9.2.3.6	12	
	9.1.3.6	10	
	9.1.4.2	4	
10	8.8.8.2	20	40
	9.1.1.3	10	
	9.8.5.1	3	
	9.8.1.1	7	
11	8.6.1.4	12	6
	9.1.5.1	2	
12	8.6.6.2	15	39
	9.8.3.4	15	
	9.2.3.4	9	
13	7.2.2.1	6	6
	9.1.3.2	4	
14	2.2.5.1	22	22
Total K = 348			

_____ Pilot
 A/C



ЧР, Усмань-Шаршки 2021		Form B
Pilot ID	CIVA Advanced Unknown3	Flight #

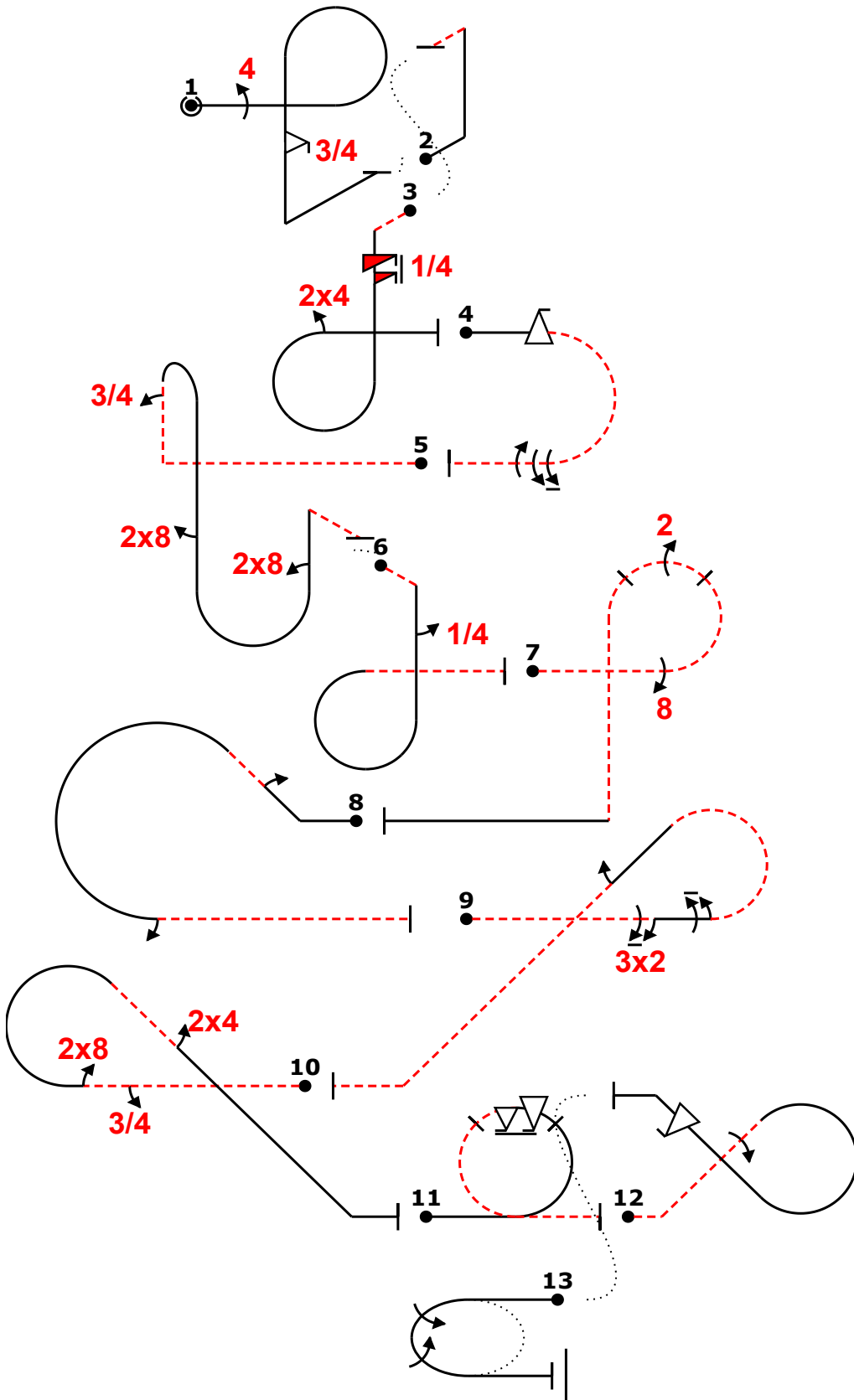
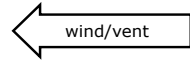

Power			
Fig	Aresti	K	
1 B	8.6.5.1	11	33
	9.4.3.4	11	
	9.9.5.3	11	
2 Add.	1.1.7.1	9	8
3 C	8.6.2.4	12	23
	9.12.1.5	6	
	9.4.3.2	5	
4 A	7.2.1.3	8	39
	9.9.3.4	11	
	9.1.3.8	12	
	9.1.3.4	8	
5 D	8.8.8.2	20	40
	9.1.1.3	10	
	9.8.5.1	3	
	9.8.1.1	7	
6 Add.	8.6.1.4	12	8
	9.1.5.1	2	
7 E	8.6.6.2	15	39
	9.8.3.4	15	
	9.2.3.4	9	
8 Add.	8.5.4.1	11	8
	9.1.2.2	6	
	9.1.3.2	4	
9 H	8.5.6.2	14	40
	9.2.3.6	12	
	9.1.3.6	10	
	9.1.4.2	4	
10 I	8.5.8.2	11	25
	9.1.3.3	6	
	9.8.3.1	3	
	9.4.4.2	5	
11 F	7.4.2.1	12	26
	9.9.3.6	14	
12 G	7.3.1.2	14	37
	9.1.2.4	10	
	9.9.2.4	13	
13 J	2.2.5.1	22	22
Total K = 348			

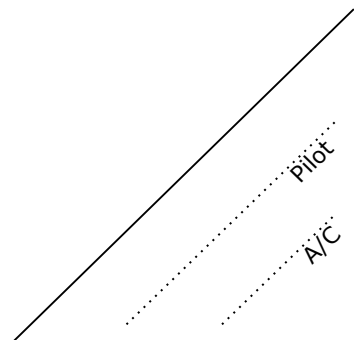

Вариант Н



ЧР, Усмань-Шаршки 2021		Form B
Pilot ID	CIVA Advanced Unknown3	Flight #

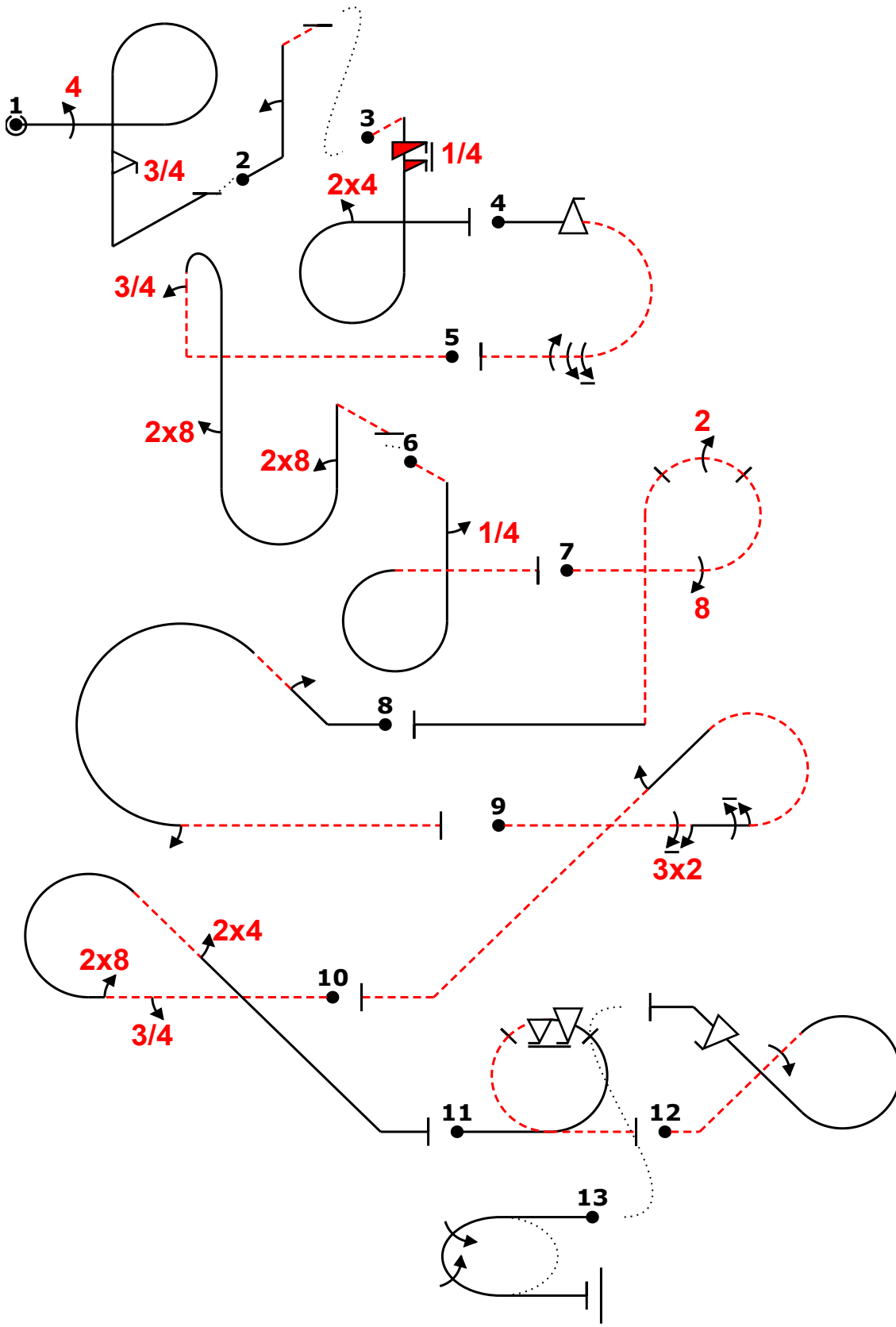
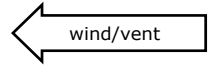

Power			
Fig	Aresti	K	
1 B	8.6.5.1	11	33
	9.4.3.4	11	
	9.9.5.3	11	
2 Add.	1.1.7.1	9	8
	9.1.1.2	8	
3 C	8.6.2.4	12	23
	9.12.1.5	6	
	9.4.3.2	5	
4 A	7.2.1.3	8	39
	9.9.3.4	11	
	9.1.3.8	12	
	9.1.3.4	8	
5 D	8.8.8.2	20	40
	9.1.1.3	10	
	9.8.5.1	3	
	9.8.1.1	7	
6 Add.	8.6.1.4	12	8
	9.1.5.1	2	
7 E	8.6.6.2	15	39
	9.8.3.4	15	
	9.2.3.4	9	
8 Add.	8.5.4.1	11	8
	9.1.2.2	6	
	9.1.3.2	4	
9 H	8.5.6.2	14	40
	9.2.3.6	12	
	9.1.3.6	10	
	9.1.4.2	4	
10 I	8.5.8.2	11	25
	9.1.3.3	6	
	9.8.3.1	3	
	9.4.4.2	5	
11 F	7.4.2.1	12	26
	9.9.3.6	14	
12 G	7.3.1.2	14	37
	9.1.2.4	10	
	9.9.2.4	13	
13 J	2.2.5.1	22	22
Total K = 348			

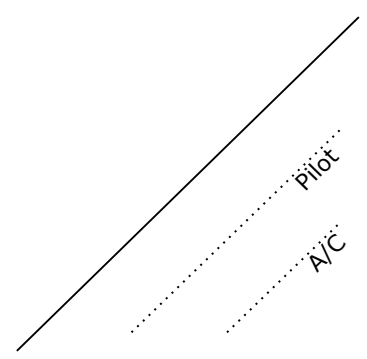

Вариант I



ЧР, Усмань-Шаршки 2021		Form B
Pilot ID	CIVA Advanced Unknown3	Flight #

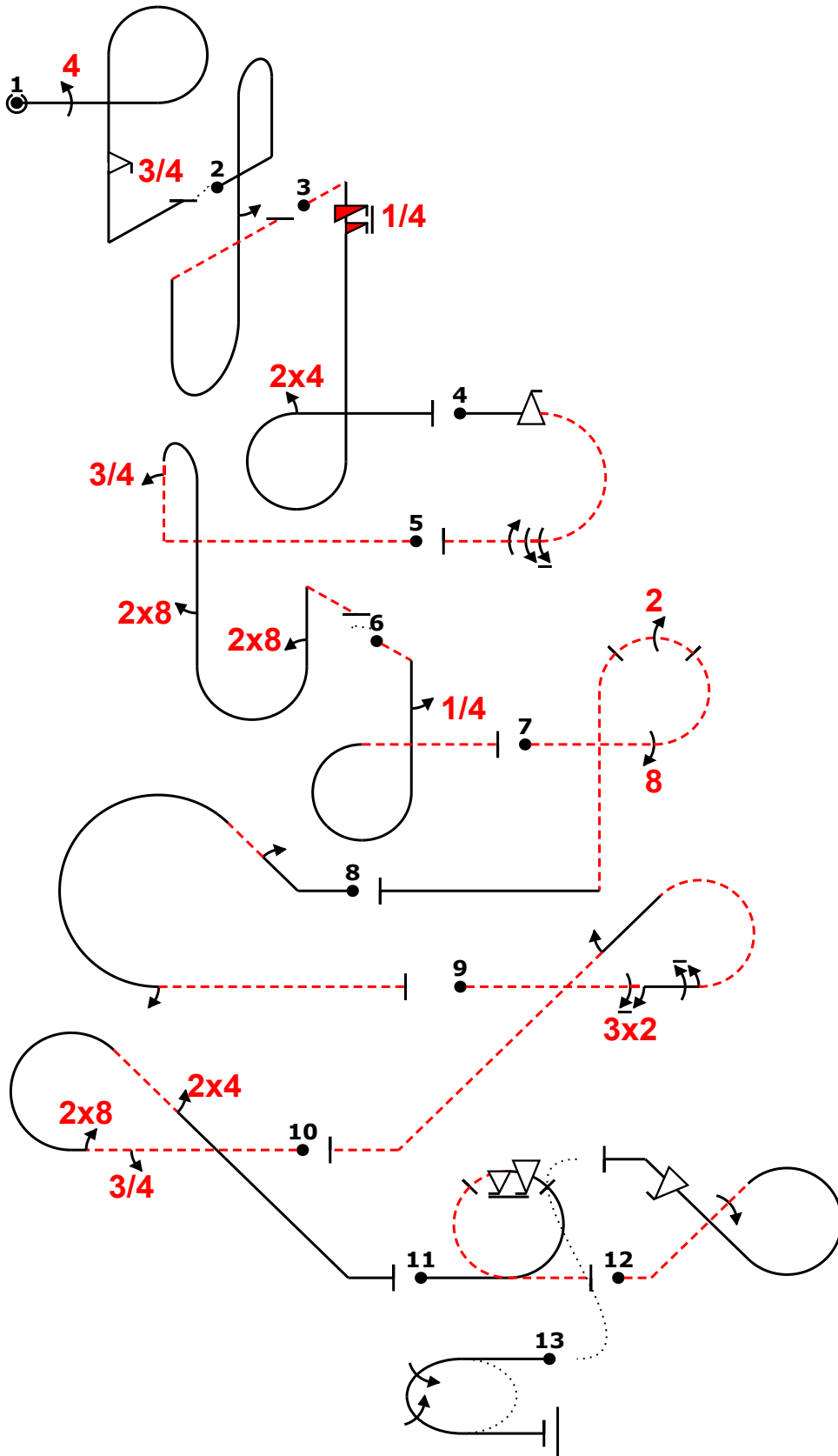
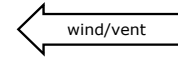

Power			
Fig	Aresti	K	
1 B	8.6.5.1	11	33
	9.4.3.4	11	
	9.9.5.3	11	
2 Add.	8.8.1.1	18	8
	9.1.5.2	4	
3 C	8.6.2.4	12	23
	9.12.1.5	6	
	9.4.3.2	5	
4 A	7.2.1.3	8	39
	9.9.3.4	11	
	9.1.3.8	12	
	9.1.3.4	8	
5 D	8.8.8.2	20	40
	9.1.1.3	10	
	9.8.5.1	3	
	9.8.1.1	7	
6 Add.	8.6.1.4	12	8
	9.1.5.1	2	
7 E	8.6.6.2	15	39
	9.8.3.4	15	
	9.2.3.4	9	
8 Add.	8.5.4.1	11	8
	9.1.2.2	6	
	9.1.3.2	4	
9 H	8.5.6.2	14	40
	9.2.3.6	12	
	9.1.3.6	10	
	9.1.4.2	4	
10 I	8.5.8.2	11	25
	9.1.3.3	6	
	9.8.3.1	3	
	9.4.4.2	5	
11 F	7.4.2.1	12	26
	9.9.3.6	14	
12 G	7.3.1.2	14	37
	9.1.2.4	10	
	9.9.2.4	13	
13 J	2.2.5.1	22	22
Total K = 348			

_____/ Pilot
/ A/C



ЧР, Усмань-Шаршки 2021		Form B
Pilot ID	CIVA Advanced Unknown3	Flight #

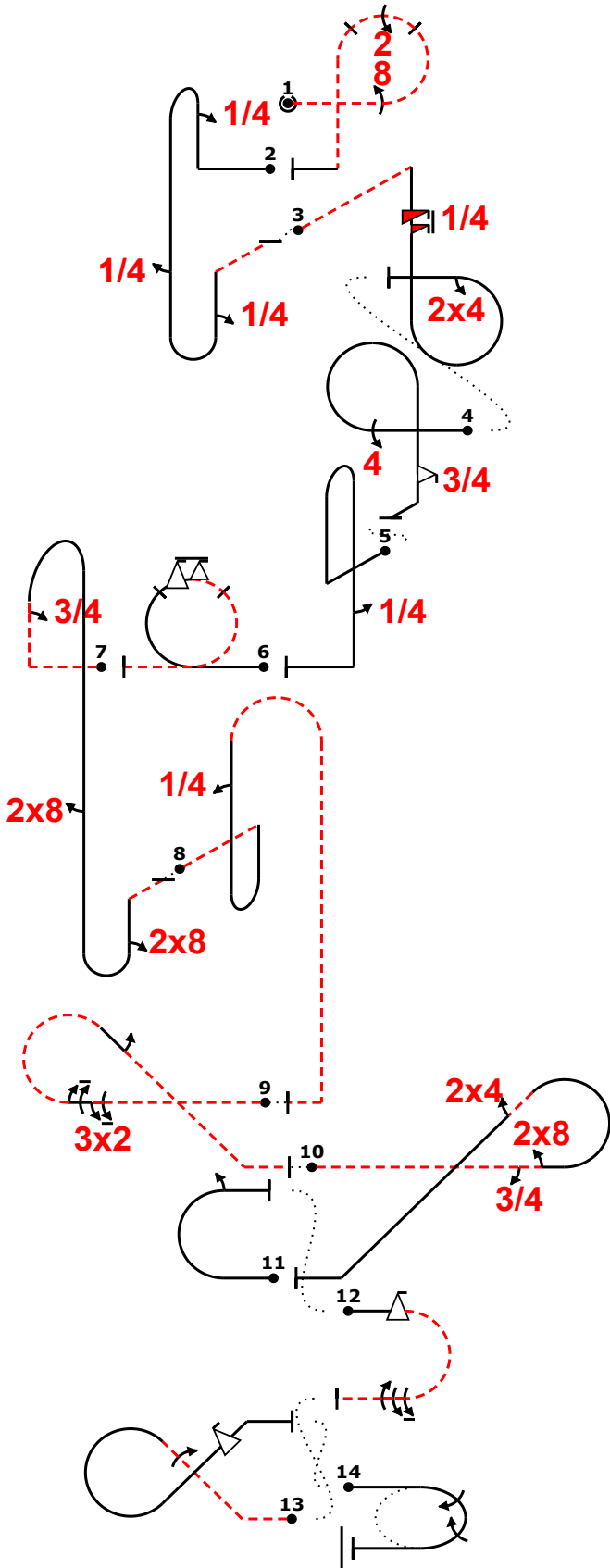
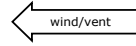

Power			
Fig	Aresti	K	
1 E	8.6.6.2	15	39
	9.8.3.4	15	
	9.2.3.4	9	
2 Add.	8.8.1.1	18	6
	9.1.1.1	6	
	9.1.5.1	2	
	9.1.1.1	6	
3 C	8.6.2.4	12	23
	9.12.1.5	6	
	9.4.3.2	5	
4 B	8.6.5.1	11	33
	9.4.3.4	11	
	9.9.5.3	11	
5 Add.	8.4.1.1	13	6
	9.1.5.1	2	
6 F	7.4.2.1	12	26
	9.9.3.6	14	
7 D	8.8.8.2	20	40
	9.1.1.3	10	
	9.8.5.1	3	
	9.8.1.1	7	
8 Add.	8.8.4.4	22	6
	9.1.1.1	6	
9 H	8.5.6.2	14	40
	9.2.3.6	12	
	9.1.3.6	10	
	9.1.4.2	4	
10 I	8.5.8.2	11	25
	9.1.3.3	6	
	9.8.3.1	3	
	9.4.4.2	5	
11 Add.	7.2.2.1	6	6
	9.1.3.2	4	
12 A	7.2.1.3	8	39
	9.9.3.4	11	
	9.1.3.8	12	
	9.1.3.4	8	
13 G	7.3.1.2	14	37
	9.1.2.4	10	
	9.9.2.4	13	
14 J	2.2.5.1	22	22
Total K = 348			

_____ Pilot
 A/C