

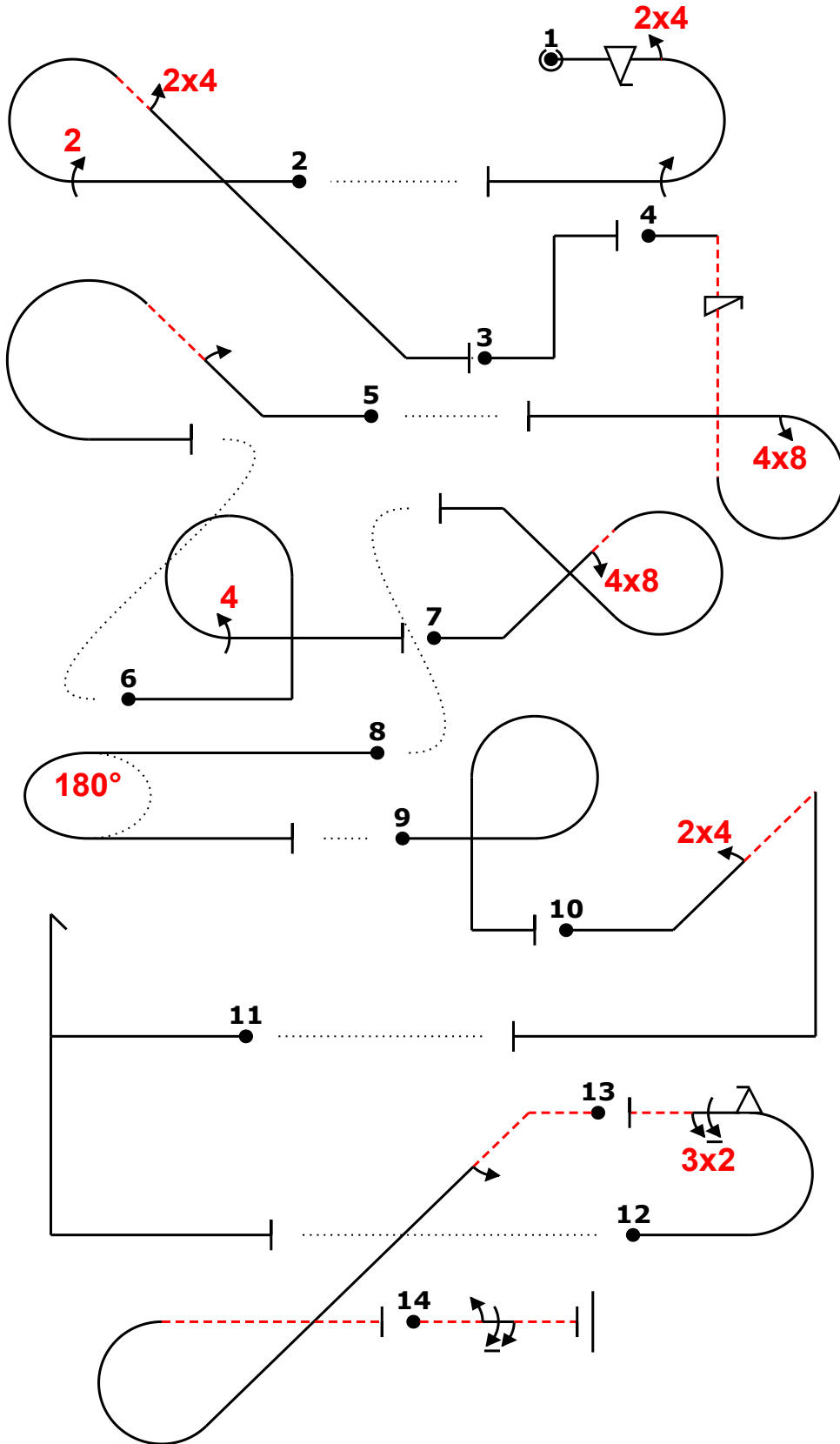

| | | |
|------------------------|----------------------------|----------|
| ЧР, Усмань-Шаршки 2021 | | Form B |
| Pilot ID | CIVA Intermediate Unknown3 | Flight # |

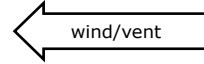

| Power | | | |
|----------------------|----------|----|----|
| Fig | Aresti | K | |
| 1 B | 7.2.3.3 | 6 | 30 |
| | 9.9.3.4 | 11 | |
| | 9.4.3.2 | 5 | |
| | 9.1.3.4 | 8 | |
| 2 D | 8.5.6.1 | 10 | 24 |
| | 9.2.3.4 | 9 | |
| | 9.4.4.2 | 5 | |
| 3 Add. | 1.1.6.1 | 10 | 6 |
| 4 C | 8.6.4.3 | 13 | 25 |
| | 9.11.1.4 | 5 | |
| | 9.8.3.2 | 7 | |
| 5 Add. | 8.5.2.1 | 10 | 6 |
| | 9.1.2.2 | 6 | |
| 6 E | 8.6.1.1 | 11 | 22 |
| | 9.4.3.4 | 11 | |
| 7 F | 7.3.2.1 | 14 | 23 |
| | 9.8.2.2 | 9 | |
| 8 Add. | 2.2.1.1 | 4 | 6 |
| 9 Add. | 8.6.5.1 | 11 | 6 |
| 10 H | 1.2.3.1 | 12 | 19 |
| | 9.4.2.2 | 7 | |
| 11 G | 5.2.1.1 | 17 | 17 |
| 12 A | 7.2.1.1 | 6 | 29 |
| | 9.9.3.2 | 11 | |
| | 9.2.3.6 | 12 | |
| 13 J | 8.5.2.4 | 11 | 15 |
| | 9.1.4.2 | 4 | |
| 14 I | 1.1.1.2 | 3 | 17 |
| | 9.1.3.2 | 4 | |
| | 9.1.3.6 | 10 | |
| Total K = 245 | | | |

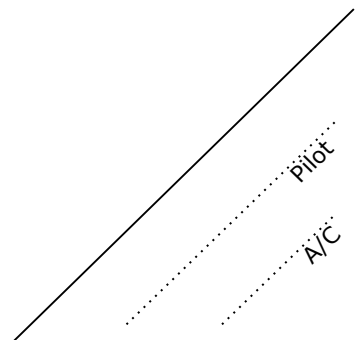



| | | |
|------------------------|----------------------------|----------|
| ЧР, Усмань-Шаршки 2021 | | Form B |
| Pilot ID | CIVA Intermediate Unknown3 | Flight # |

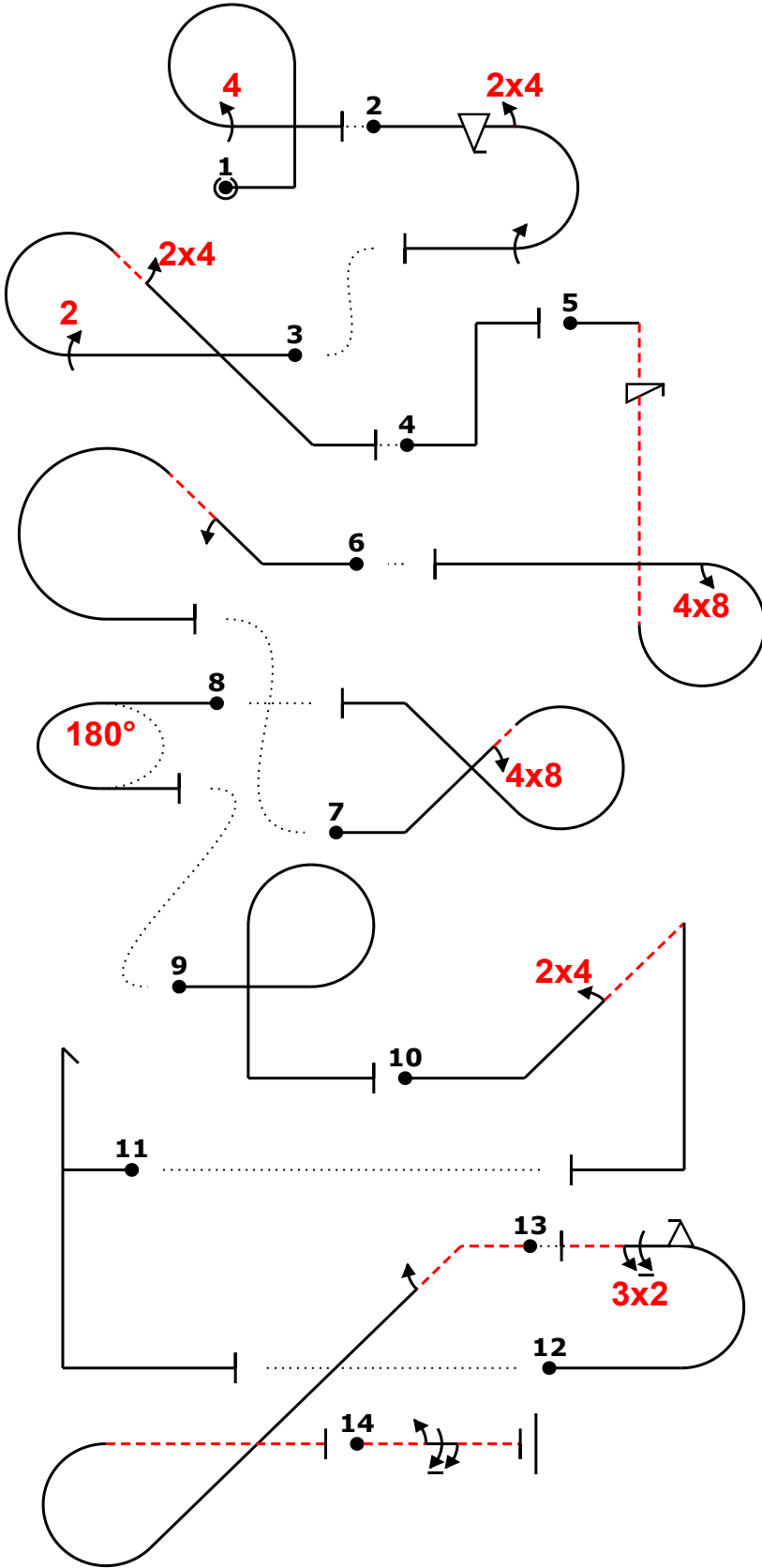
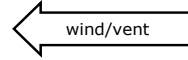

| Power | | | |
|----------------------|--------------|----|----|
| Fig | Aresti | K | |
| 1 | 8.6.1.1 | 11 | 22 |
| | E 9.4.3.4 | 11 | |
| 2 | 7.2.3.3 | 6 | 30 |
| | B 9.9.3.4 | 11 | |
| | 9.4.3.2 | 5 | |
| | 9.1.3.4 | 8 | |
| 3 | 8.5.6.1 | 10 | 24 |
| | D 9.2.3.4 | 9 | |
| | 9.4.4.2 | 5 | |
| 4 | 1.1.6.1 | 10 | 6 |
| 5 | 8.6.4.3 | 13 | 25 |
| | C 9.11.1.4 | 5 | |
| | 9.8.3.2 | 7 | |
| 6 | 8.5.2.1 | 10 | 6 |
| | Add. 9.1.2.2 | 6 | |
| 7 | 7.3.2.1 | 14 | 23 |
| | F 9.8.2.2 | 9 | |
| 8 | 2.2.1.1 | 4 | 6 |
| 9 | 8.6.5.1 | 11 | 6 |
| 10 | 1.2.3.1 | 12 | 19 |
| | H 9.4.2.2 | 7 | |
| 11 | 5.2.1.1 | 17 | 17 |
| 12 | 7.2.1.1 | 6 | 29 |
| | A 9.9.3.2 | 11 | |
| | 9.2.3.6 | 12 | |
| 13 | 8.5.2.4 | 11 | 15 |
| | J 9.1.4.2 | 4 | |
| 14 | 1.1.1.2 | 3 | 17 |
| | I 9.1.3.2 | 4 | |
| | 9.1.3.6 | 10 | |
| Total K = 245 | | | |

_____ Pilot
 A/C

Вариант С



| | | |
|----------|----------------------------|----------|
| | | Form B |
| Pilot ID | CIVA Intermediate Unknown3 | Flight # |

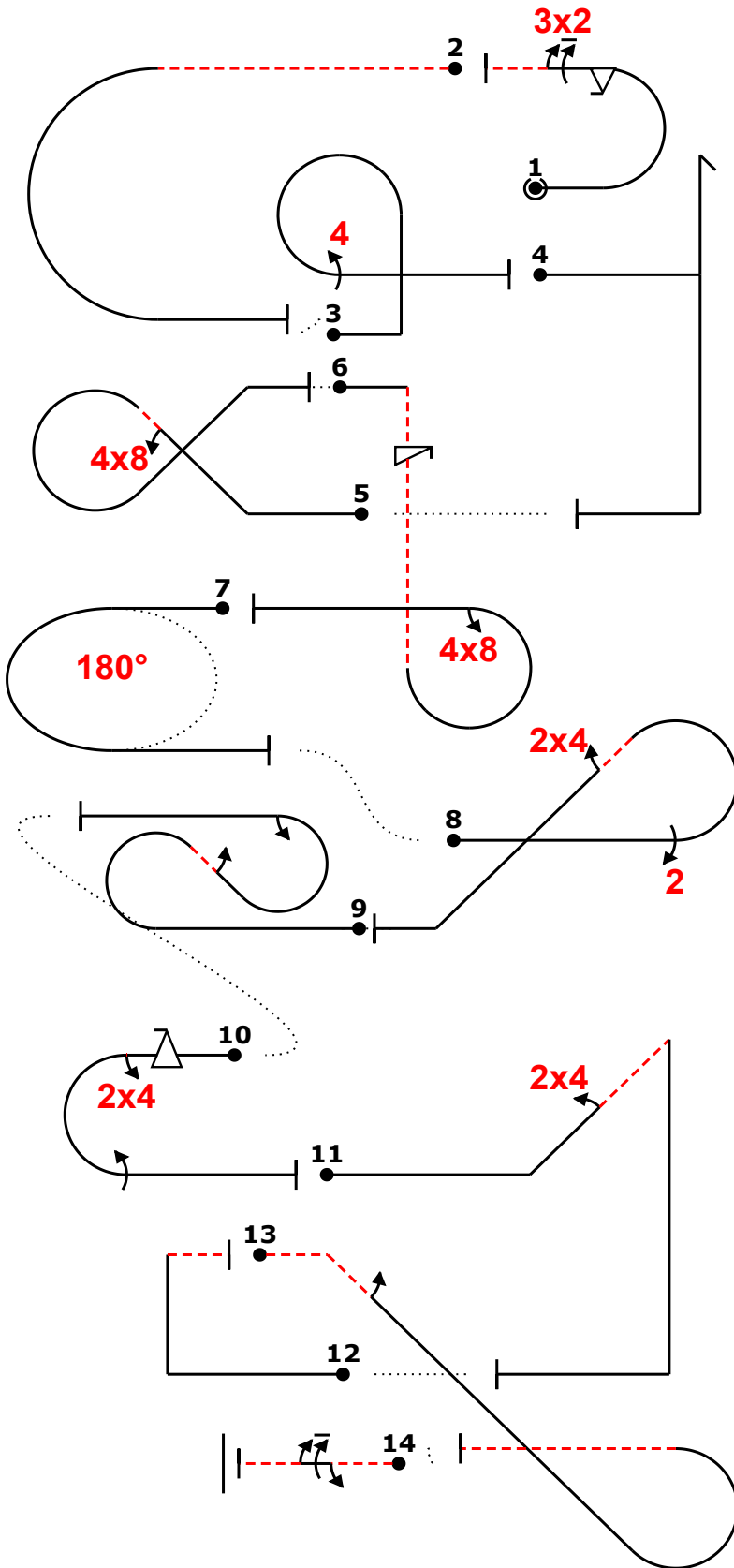
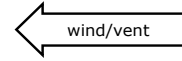

| Power | | | |
|----------------------|----------|----|----|
| Fig | Aresti | K | |
| 1 A | 7.2.1.1 | 6 | 29 |
| | 9.9.3.2 | 11 | |
| | 9.2.3.6 | 12 | |
| 2 Add. | 7.2.1.4 | 6 | 6 |
| 3 E | 8.6.1.1 | 11 | 22 |
| | 9.4.3.4 | 11 | |
| 4 G | 5.2.1.1 | 17 | 17 |
| 5 F | 7.3.2.1 | 14 | 23 |
| | 9.8.2.2 | 9 | |
| 6 C | 8.6.4.3 | 13 | 25 |
| | 9.11.1.4 | 5 | |
| | 9.8.3.2 | 7 | |
| 7 Add. | 2.2.1.1 | 4 | 6 |
| 8 D | 8.5.6.1 | 10 | 24 |
| | 9.2.3.4 | 9 | |
| | 9.4.4.2 | 5 | |
| 9 Add. | 7.5.7.1 | 15 | 6 |
| | 9.1.4.2 | 4 | |
| | 9.1.3.2 | 4 | |
| 10 B | 7.2.3.3 | 6 | 30 |
| | 9.9.3.4 | 11 | |
| | 9.4.3.2 | 5 | |
| | 9.1.3.4 | 8 | |
| 11 H | 1.2.3.1 | 12 | 19 |
| | 9.4.2.2 | 7 | |
| 12 Add. | 1.1.7.1 | 9 | 6 |
| 13 J | 8.5.2.4 | 11 | 15 |
| | 9.1.4.2 | 4 | |
| 14 I | 1.1.1.2 | 3 | 17 |
| | 9.1.3.2 | 4 | |
| | 9.1.3.6 | 10 | |
| Total K = 245 | | | |

_____ Pilot
 A/C



| | | |
|------------------------|----------------------------|----------|
| ЧР, Усмань-Шаршки 2021 | | Form B |
| Pilot ID | CIVA Intermediate Unknown3 | Flight # |

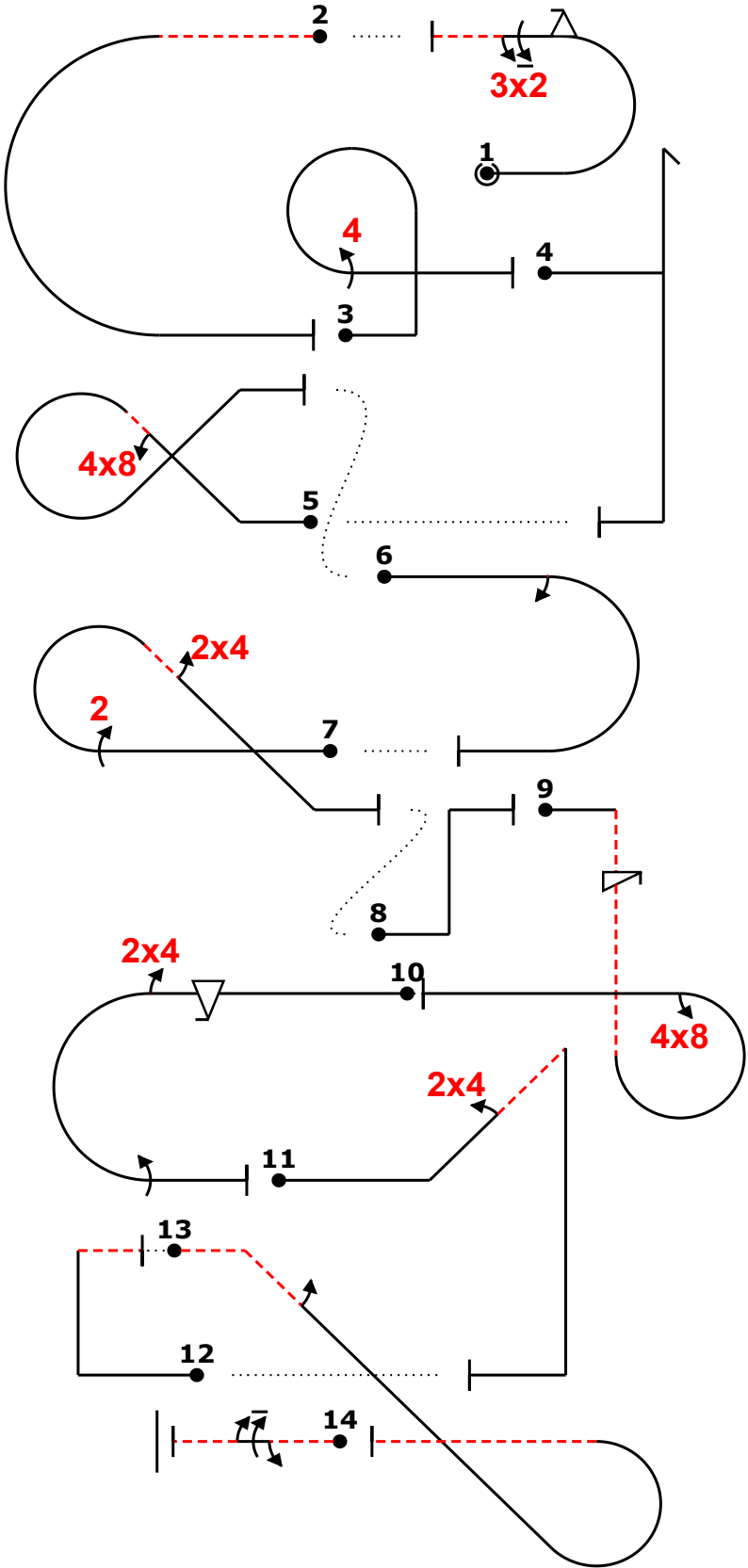
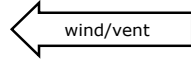

| Power | | | |
|----------------------|----------|----|----|
| Fig | Aresti | K | |
| 1 A | 7.2.1.1 | 6 | 29 |
| | 9.9.3.2 | 11 | |
| | 9.2.3.6 | 12 | |
| 2 Add. | 7.2.1.4 | 6 | 6 |
| 3 | 8.6.1.1 | 11 | 22 |
| | 9.4.3.4 | 11 | |
| 4 G | 5.2.1.1 | 17 | 17 |
| 5 | 7.3.2.1 | 14 | 23 |
| | 9.8.2.2 | 9 | |
| 6 Add. | 7.2.3.3 | 6 | 6 |
| | 9.1.3.2 | 4 | |
| 7 D | 8.5.6.1 | 10 | 24 |
| | 9.2.3.4 | 9 | |
| | 9.4.4.2 | 5 | |
| 8 Add. | 1.1.6.1 | 10 | 6 |
| 9 C | 8.6.4.3 | 13 | 25 |
| | 9.11.1.4 | 5 | |
| | 9.8.3.2 | 7 | |
| 10 B | 7.2.3.3 | 6 | 30 |
| | 9.9.3.4 | 11 | |
| | 9.4.3.2 | 5 | |
| | 9.1.3.4 | 8 | |
| 11 H | 1.2.3.1 | 12 | 19 |
| | 9.4.2.2 | 7 | |
| 12 Add. | 1.1.7.1 | 9 | 6 |
| 13 J | 8.5.2.4 | 11 | 15 |
| | 9.1.4.2 | 4 | |
| 14 I | 1.1.1.2 | 3 | 17 |
| | 9.1.3.2 | 4 | |
| | 9.1.3.6 | 10 | |
| Total K = 245 | | | |

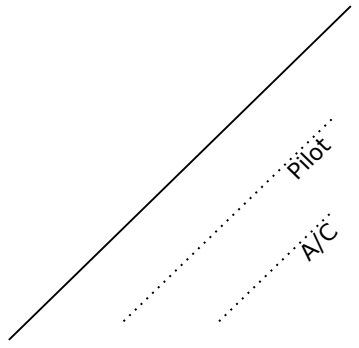



| | | |
|------------------------|----------------------------|----------|
| ЧР, Усмань-Шаршки 2021 | | Form B |
| Pilot ID | CIVA Intermediate Unknown3 | Flight # |

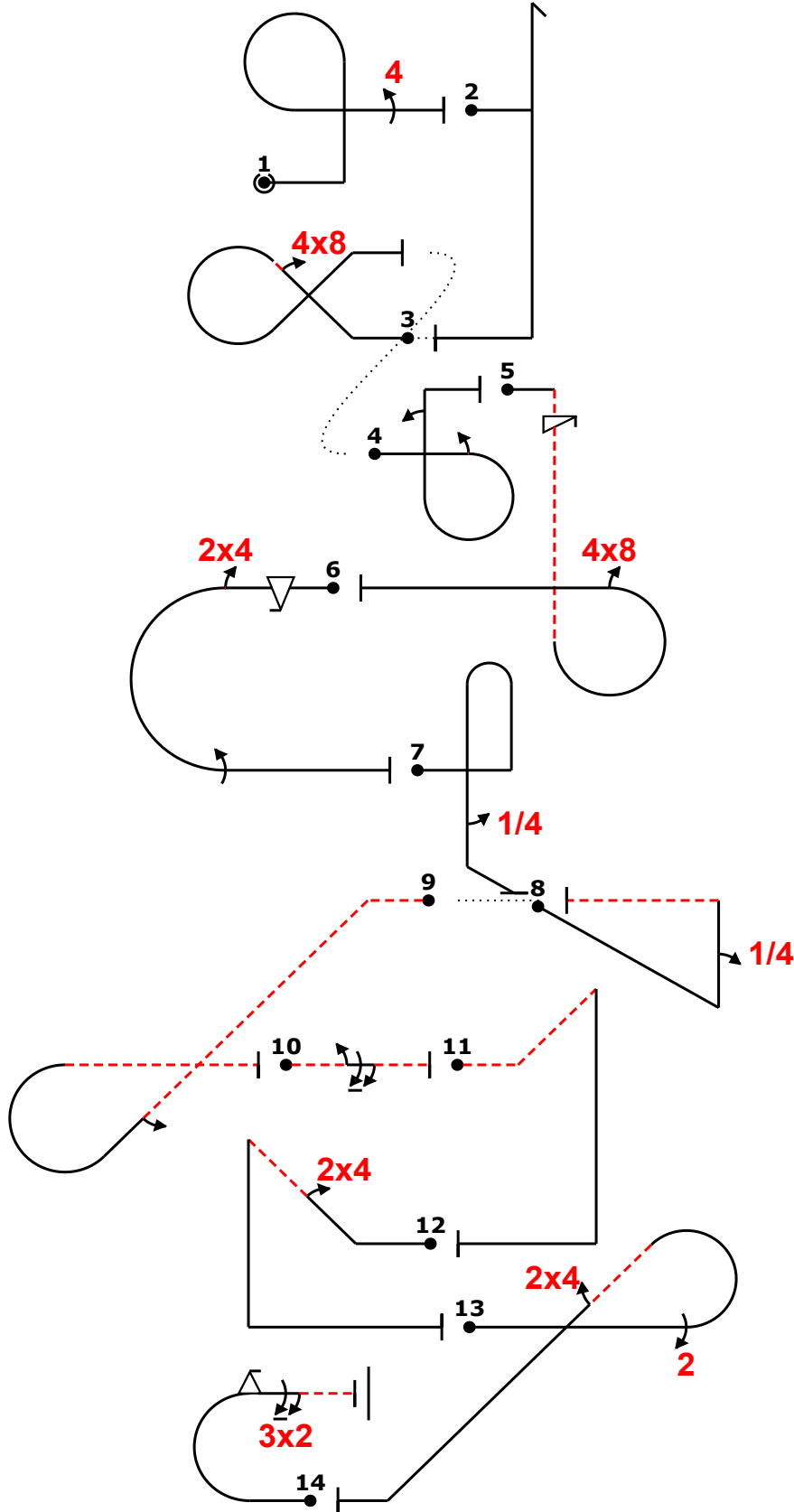
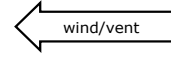

| Power | | | |
|----------------------|----------|----|----|
| Fig | Aresti | K | |
| 1 | 8.6.1.1 | 11 | 22 |
| E | 9.4.3.4 | 11 | |
| 2 | 5.2.1.1 | 17 | 17 |
| G | | | |
| 3 | 7.3.2.1 | 14 | 23 |
| F | 9.8.2.2 | 9 | |
| 4 | 8.6.8.3 | 12 | 6 |
| Add. | 9.1.3.2 | 4 | |
| | 9.1.1.2 | 8 | |
| 5 | 8.6.4.3 | 13 | 25 |
| C | 9.11.1.4 | 5 | |
| | 9.8.3.2 | 7 | |
| 6 | 7.2.3.3 | 6 | 30 |
| B | 9.9.3.4 | 11 | |
| | 9.4.3.2 | 5 | |
| | 9.1.3.4 | 8 | |
| 7 | 8.4.1.1 | 13 | 6 |
| Add. | 9.1.5.1 | 2 | |
| 8 | 1.1.7.1 | 9 | 6 |
| Add. | 9.1.1.1 | 6 | |
| 9 | 8.5.2.4 | 11 | 15 |
| J | 9.1.4.2 | 4 | |
| 10 | 1.1.1.2 | 3 | 17 |
| I | 9.1.3.2 | 4 | |
| | 9.1.3.6 | 10 | |
| 11 | 1.2.2.2 | 13 | 6 |
| Add. | | | |
| 12 | 1.2.3.1 | 12 | 19 |
| H | 9.4.2.2 | 7 | |
| 13 | 8.5.6.1 | 10 | 24 |
| D | 9.2.3.4 | 9 | |
| | 9.4.4.2 | 5 | |
| 14 | 7.2.1.1 | 6 | 29 |
| A | 9.9.3.2 | 11 | |
| | 9.2.3.6 | 12 | |
| Total K = 245 | | | |

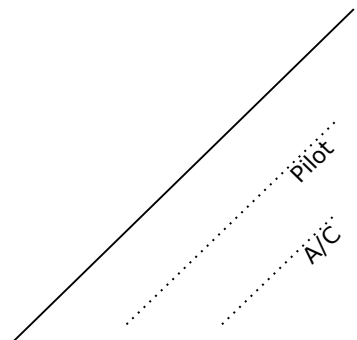



| | | |
|------------------------|----------------------------|----------|
| ЧР, Усмань-Шаршки 2021 | | Form B |
| Pilot ID | CIVA Intermediate Unknown3 | Flight # |

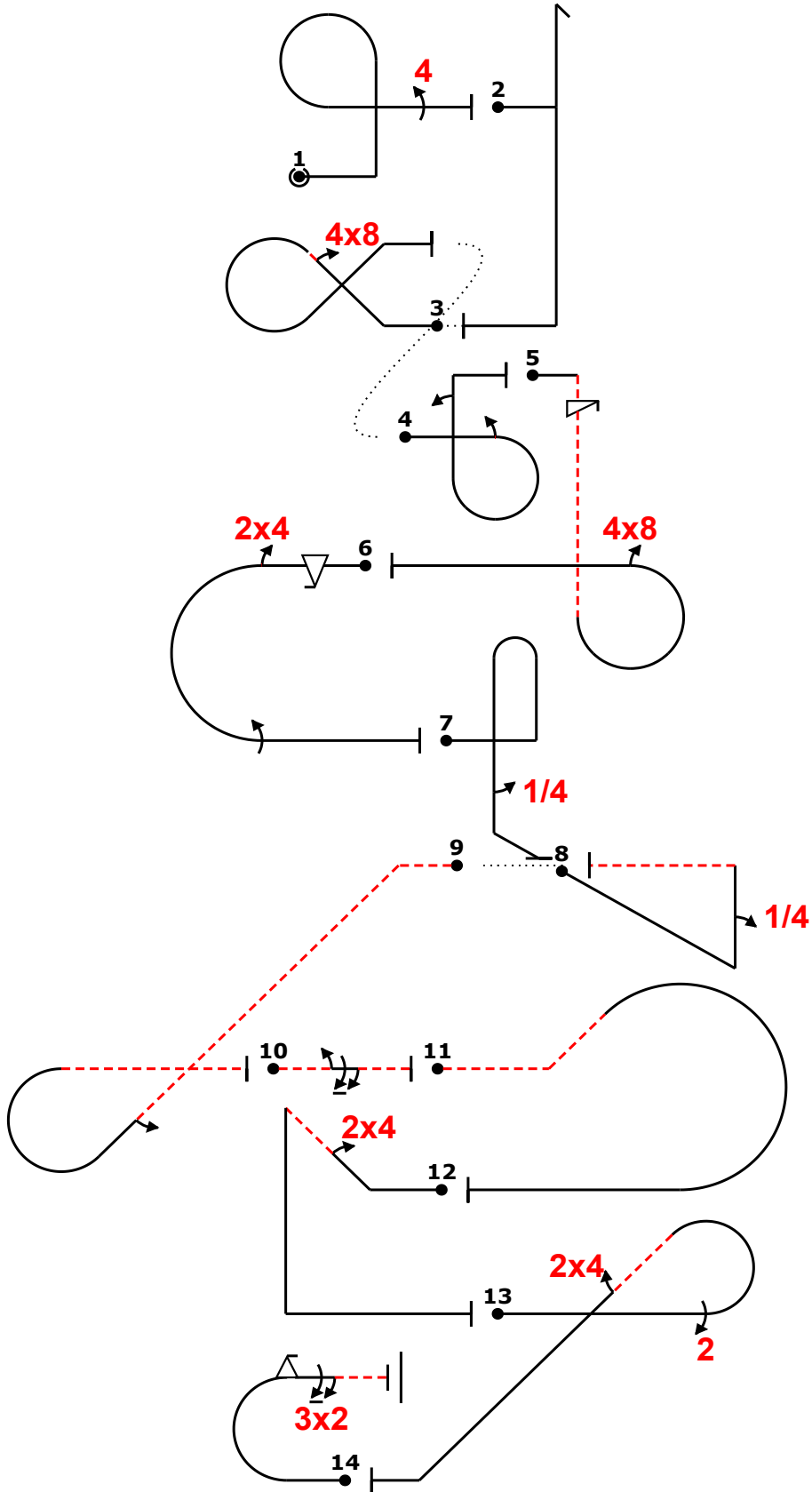
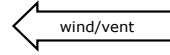

| Power | | | |
|----------------------|----------|----|----|
| Fig | Aresti | K | |
| 1 | 8.6.1.1 | 11 | 22 |
| E | 9.4.3.4 | 11 | |
| 2 | 5.2.1.1 | 17 | 17 |
| G | | | |
| 3 | 7.3.2.1 | 14 | 23 |
| F | 9.8.2.2 | 9 | |
| 4 | 8.6.8.3 | 12 | 6 |
| Add. | 9.1.3.2 | 4 | |
| | 9.1.1.2 | 8 | |
| 5 | 8.6.4.3 | 13 | 25 |
| C | 9.11.1.4 | 5 | |
| | 9.8.3.2 | 7 | |
| 6 | 7.2.3.3 | 6 | 30 |
| B | 9.9.3.4 | 11 | |
| | 9.4.3.2 | 5 | |
| | 9.1.3.4 | 8 | |
| 7 | 8.4.1.1 | 13 | 6 |
| Add. | 9.1.5.1 | 2 | |
| 8 | 1.1.7.1 | 9 | 6 |
| Add. | 9.1.1.1 | 6 | |
| 9 | 8.5.2.4 | 11 | 15 |
| J | 9.1.4.2 | 4 | |
| 10 | 1.1.1.2 | 3 | 17 |
| I | 9.1.3.2 | 4 | |
| | 9.1.3.6 | 10 | |
| 11 | 8.5.1.2 | 10 | 6 |
| Add. | | | |
| 12 | 1.2.3.1 | 12 | 19 |
| H | 9.4.2.2 | 7 | |
| 13 | 8.5.6.1 | 10 | 24 |
| D | 9.2.3.4 | 9 | |
| | 9.4.4.2 | 5 | |
| 14 | 7.2.1.1 | 6 | 29 |
| A | 9.9.3.2 | 11 | |
| | 9.2.3.6 | 12 | |
| Total K = 245 | | | |

